

User manual

PV Grid-Connected Inverter

Product Model:Sofar 3.3K-12KTL-X Document Version 1.2(2018.4.4)



Notice

This manual contains important safety instructions that must be followed during installation and maintenance of the equipment.

Save these instructions!

This manual must be considered as an integral part of the equipment, and must be available at all times to everyone who interacts with the equipment. The manual must always accompany the equipment, even when it is transferred to another user or field.

Copyright Declaration

The copyright of this manual belongs to Shenzhen SOFARSOLAR Co., Ltd. Any corporation or individual should not plagiarize, partially copy or fully copy it (including software, etc.), and no reproduction or distribution of it in any form or by any means. All rights reserved. SOLARSOFAR reserves the right of final interpretation. This manual is subject to change according to user's or customer's feedback. Please check our website at <http://www.sofarsolar.com> for latest version.

Shenzhen SOFARSOLAR Co., Ltd.

ADD: Building NO.4, Antongda Industrial Park, NO.1, Liuxian Avenue, Bao'an District, Shenzhen, China

[Http://www.sofarsolar.com](http://www.sofarsolar.com)

P. C. : 518000

E-mail: service@sofarsolar.com

Preface

Outline

Please read the product manual carefully before installation, operation or maintenance. This manual contains important safety instructions and installation instructions that must be followed during installation and maintenance of the equipment.

• Scope

This product manual describes the assembly, installation, commissioning, and maintenance of the following inverters.

3.3KTL-X ; 4.4KTL-X ; 5.5KTL-X ; 6.6KTL-X ; 8.8KTL-X ; 11KTL-X ; 12KTL-X.

Keep this manual where it will be accessible at all times.

• Target Group

This manual is for qualified person (support person, service person are qualified mentioned in this manual).

• Symbols Used

This manual provides safety operation information and uses the symbol in order to ensure personal and property security and use the inverter efficiently when operating the inverter. You must understand these emphasize information to avoid the personal injury and property loss. Please read the following symbols which used in this manual carefully.







 Danger	Danger indicates a hazardous situation which, if not avoided, will result in death or serious injury.
 Warning	Warning indicates a hazardous situation which, if not avoided, could result in death or serious injury.
 Caution	Caution indicates a hazardous situation, if not avoided, could result in minor or moderate injury.
 Attention	Attention indicates there are potential risks. If fail to prevent, may lead to equipment cannot run normally or property damage.
 Note	Note provides tips that are valuable for the optimal operation of the product.

Table of contents

Preface	III
1 Basic safety information	1
1.1 Safety instructions	1
1.2 Symbols and signs	3
2 Product characteristics	5
2.1 Product identification	5
2.2 Function description	7
2.3 Protection modules	8
3 Installation	9
3.1 Installation Process	9
3.2 Checking Before Installation	9
3.3 Tools	11
3.4 Determining the Installation Position	13
3.5 Installing the Sofar 3.3K~12KTL-X	14
4 Electrical Connections	16
4.1 Electrical connection	16
4.2 Connecting PGND Cables	16
4.3 Connecting AC Output Power Cables	17
4.4 Connecting Communications Cables	19
4.5 Connecting DC Input Power Cables	23
4.6 Safety check	28
5 Commissioning of inverter	29
5.1 Safety inspection before commissioning	29
5.2 Start inverter	29

6 Operation interface	30
6.1 Operation and Display Panel	30
6.2 Standard Interface	31
6.3 Main Interface	33
7 Trouble shooting and maintenance	45
7.1 Trouble shooting	45
7.2 Maintenance	49
8 Decommissioning	50
8.1 Decommissioning steps	50
8.2 Package	50
8.3 Storage	50
8.4 Disposal	50
9 Technical data	51
9.1 Input parameter (DC)	51
9.2 Output parameter (AC)	52
9.3 Efficiency, Safety and Protection	52
9.4 General Data	53
10 Quality Assurance	54

Basic safety information

	<p>If you have any question or problem when you read the following information, please contact Shenzhen SOFARSOLAR Co., Ltd.</p>
Note	

1.1 Safety instructions

Read and understand the instruction of this manual ,and be familiar with relevant safety symbols in the paragraph, then start to install and debug the equipment.According to the national and state requirements, before connect the grid ,you must get power department permission, and perform the operation only by qualified electrical engineer.Before installing and maintaining the equipment, you should cut off the high voltage application of PV array. You can also open the switch of Solar Array Combiner to cut off the high voltage. Otherwise, serious injury may be caused.

Qualified persons

The customer must make sure the operator has the necessary skill and training to do his/her job. Staff in charge of using and maintaining the equipment must be skilled, aware and mature for the described tasks and must have the reliability to correctly interpret what is described in the manual. For safety reason only a qualified electrician, who has received training and / or has demonstrated skills and knowledge in construction and in operation of this unit, can install this inverter. Shenzhen SOFARSOLAR Co., Ltd does not take any responsibility for the property destruction and personal injury because of any incorrect use.

Assembly situation requirements





Please install and start inverter according to the following sections. Put the inverter in appropriate bearing capacity objects(such as wall and components and so on), to ensure that inverter vertical placed. Choose suitable place for installing electrical equipment. And assure enough fire exit space, convenience for maintenance. Maintain proper ventilation, and ensure that have the enough air cooling cycle.

Transport requirements



If you find packing problems that may cause the damage of the inverter, or find any visible damage, please immediately notice the responsible transportation company. You can ask solar equipment installation contractor or Shenzhen SOFARSOLAR Co.Ltd for help if necessary. Transport of the equipment, especially by road, must be carried out with by suitable ways and means for protecting the components (in particular, the electronic components) from violent shocks, humidity, vibration, etc.

Electric connection



Please comply with all the current electrical regulations about accident prevention in dealing with the current inverter.

 Danger	<p>Before the electrical connection, make sure to use opaque material to cover the PV modules or to disconnect PV array DC switch. Exposure to the sun, PV array will produce a dangerous voltage!</p>
 Warning	<p>All installation accomplished only by professional electrical engineer!</p> <ul style="list-style-type: none"> • must be trained; • Completely read the manual operation and understand relevant matters.
 Attention	<p>Only get permission by the local power department and complete all electrical connection by professional electrical engineer then connect inverter into grid!</p>
 Note	<p>The equipment is composed of two cases. It's forbidden to remove the tamper evident label, and open the upper case. Otherwise Sofarsolar will not provide service and maintenance.!</p>

Operation





	<p>Touching the power grid or the terminal of equipment may lead to die of electric shock or fire!</p> <ul style="list-style-type: none"> • Don't touch the terminal or conductor which connect to the power circuit; • Pay attention to anything about grid connection and security document.
Danger	
	<p>Some internal components will be very hot when inverter is working. Please wear protective gloves!</p>
Attention	

Maintenance and repair

	<ul style="list-style-type: none"> • Disconnected with the PV components array and electricity grid before any repair work; • After turn off AC breaker and DC switch for 5 minutes later, the maintenance or repair of the inverter can be carried out!
Danger	
	<ul style="list-style-type: none"> • Inverter should work again after removing any faults. If you need any repair work, please contact with the local authorized service center; • Can't open the internal components of inverter without authorized. Shenzhen SOFARSOLAR Co., Ltd. does not take any responsibility for the losses from that.
Attention	









1.2 Symbols and signs

Safety symbols

	<p>Electromagnetic radiation from inverter may be harmful to health!</p> <ul style="list-style-type: none"> • Please do not continue to stay away from the inverter in less than 20 cm when inverter is working.
Danger	
	<p>Caution of burn injuries due to hot enclosure parts!</p> <ul style="list-style-type: none"> • During working only can touch the display and key parts of inverter.
Caution	
	<p>PV array should be connected to the ground in accordance with requirements of local power department!</p> <ul style="list-style-type: none"> • To protect system and the personnel security, we suggest that PV array of border and inverter should be reliable grounding .
Attention	
	<p>Ensure input DC voltage < Max.DC voltage .Over voltage may cause permanent damage to inverter or other losses, which will not be included in warranty!</p>
Warning	

Signs on the inverter

There are some symbols which are related to security on the inverter. Please read and understand the content of the symbols, and then start the installation.

	There is residual voltage in the inverter! Before open the equipment, operator should wait for five minutes to ensure the capacitance discharge completely.
	Be careful of high voltage.
	Be careful of high temperature.
	Conformity with European.
	Point of connection for grounding.
	This indicates the allowed temperature range.
	This indicates the degree of protection of the equipment according to IEC standard 70-1 (EN 60529 June 1997).
	Positive pole and negative pole of the input voltage (DC).

2 Product characteristics

2.1 Product identification

The Sofar inverters are grid-tied inverters which convert DC current generated by PV modules into AC current and feed it into the public grid.

Figure2-1 Interface figure

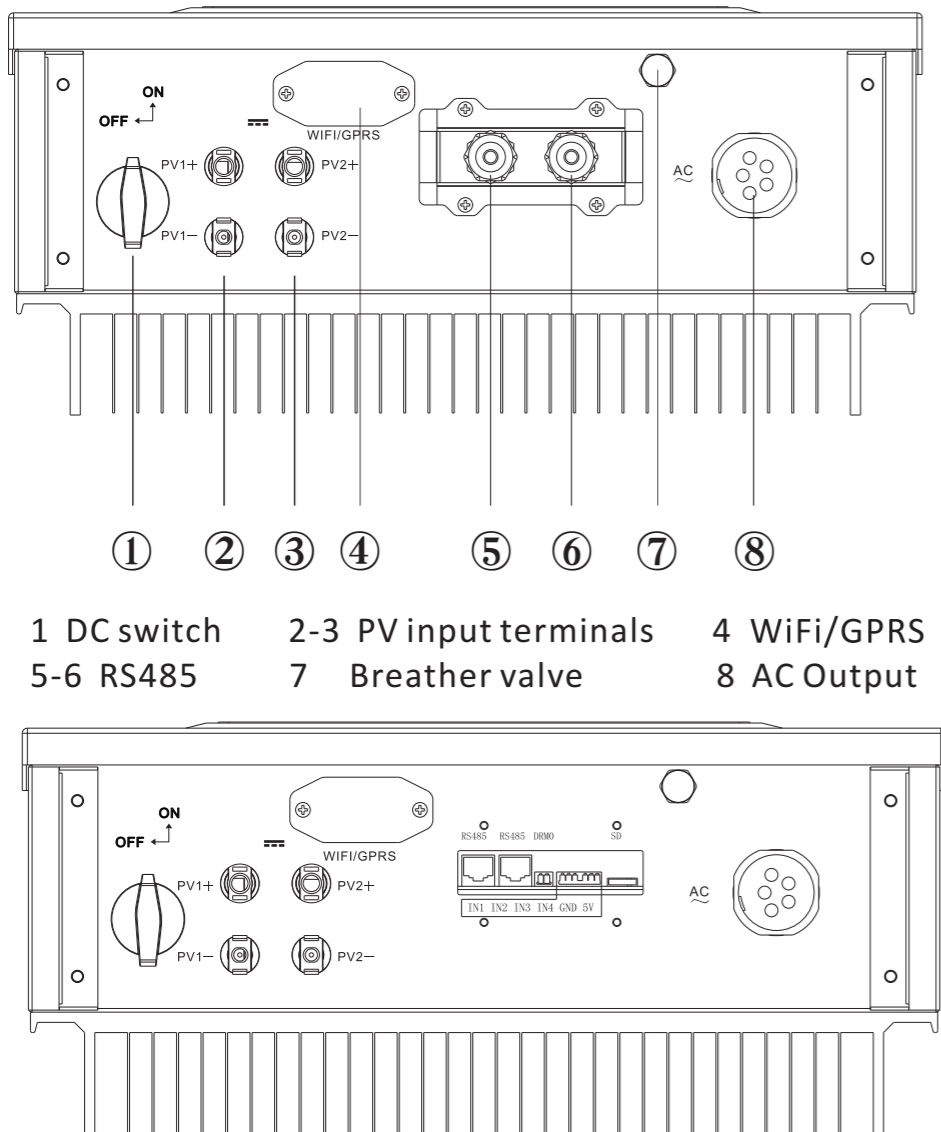

- 1 DC switch
- 2-3 PV input terminals
- 4 WiFi/GPRS
- 5-6 RS485
- 7 Breather valve
- 8 AC Output

Figure2-2 Inverter front & flank & Dimensions

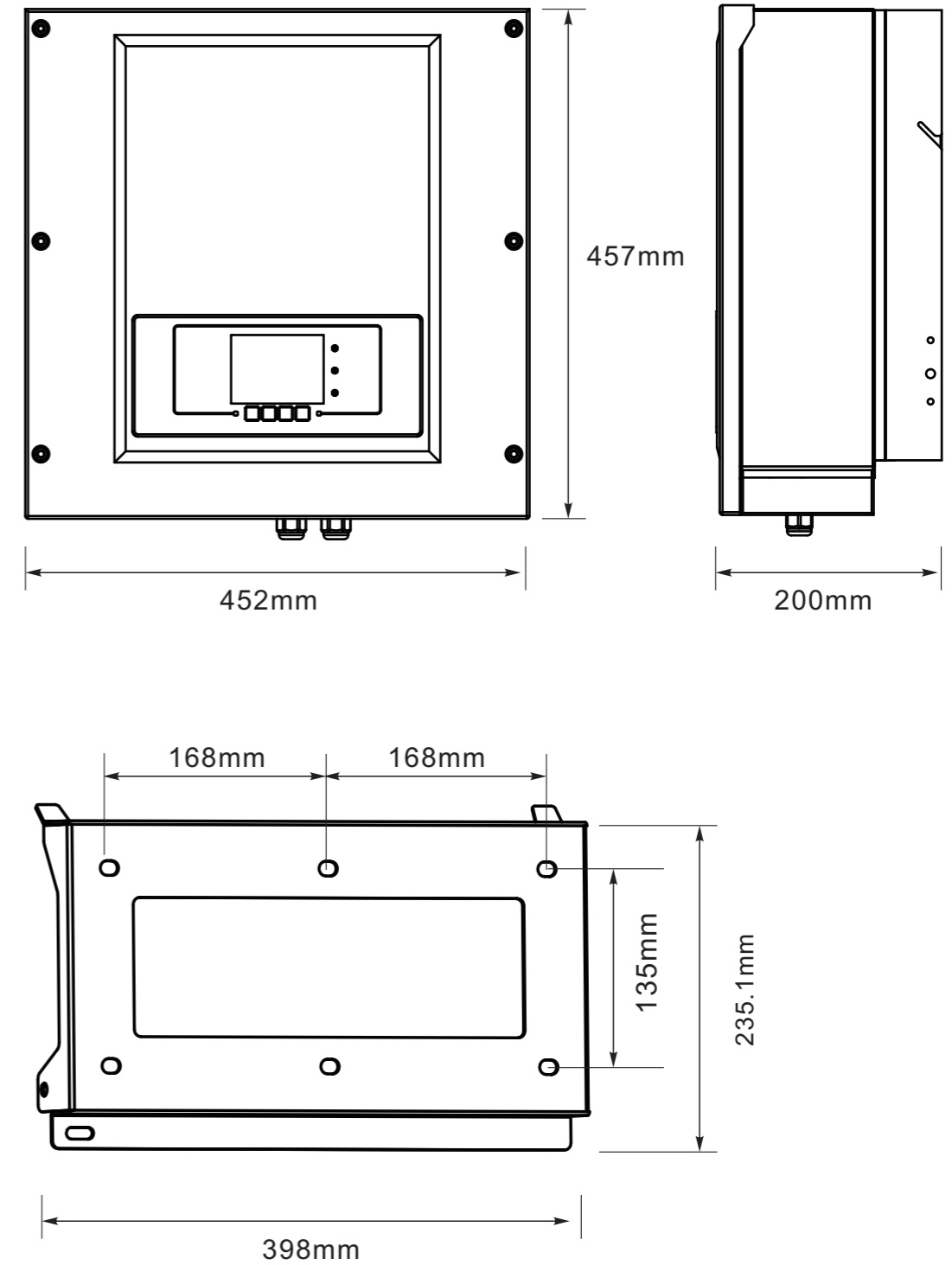

Intended grid types:

Sofar 3.3K ~ 12KTL-X inverters are compatible with TN-S, TN-C, TN-C-S, TT, IT grid configurations. For the TT type of electricity grid, the voltage between neutral and earth should be less than 30V.

Figure2-2 Overview of the grid configurations

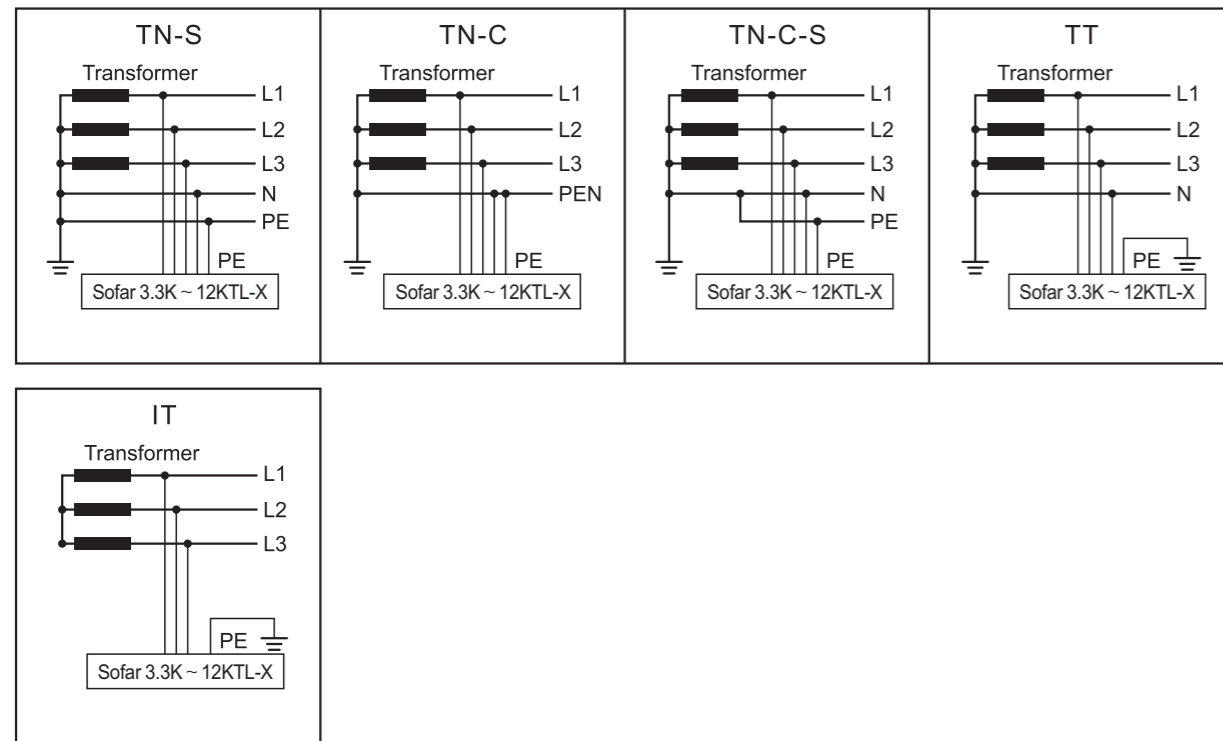

2.2 Function description

Function module

A. Data transmission

The inverter may be monitored remotely through an advanced communications system based on an RS485 serial interface, or remotely via the WIFI.

B. Energy management unit

B.1 Remote switching on/off

This control can be used to switch the inverter on/off through an external (remote) control.

B.2 Feeding reactive power into the grid

The inverter is able to produce reactive power and can therefore feed it into the grid through the setting of the phase shift factor. Feed-in management can be controlled directly by the grid company through a dedicated RS485 serial interface.

B.3 Limiting the active power fed into the grid

The inverter, if enabled can limit the amount of active power fed into the grid by the inverter to the desired value (expressed as a percentage).

B.4 Self power reduction when grid over frequency

When the grid frequency is over limited value, inverter will reduce output power which do good to the grid stability.

B.5 Power reduction due to environmental conditions, input output voltage

The power reduction value and the inverter temperature at which it occurs depend on the ambient temperature and on many operating para-meters. Example: input voltage, grid voltage and power available from the photovoltaic field. The inverter can therefore reduce the power during certain periods of the day and according to the value of these parameters.

C. Software update

SD card is used for updating the firmware.

2.3 Protection modules

A. Anti-islanding

In the event of a local grid outage by the electricity company, or when the equipment is switched off for maintenance operations, the inverter must be physically disconnected safely, to ensure protection of people working on the grid, all in accordance with the relevant national standards and laws. To prevent possible islanding, the inverter is equipped with an automatic protective disconnection system called “Anti-Islanding”.

B. RCMU

Sofar inverters are equipped with a redundancy on the reading of the ground leakage current sensitive to all components of both direct and alternating current. Measurement of the ground leakage current is carried out at the same time and independently by 2 different processors: it is sufficient for one of the two to detect an anomaly to trip the protection, with consequent separation from the grid and stopping of the conversion process.

C. Grid monitoring

Continuous monitoring of the grid voltage to ensure the voltage and frequency values stay within operating limits.

D. Inverter internal device protection

The inverter has all kinds of internal protection to protect the device inside when grid or input DC side have abnormal situation.

E. Ground fault protection

This inverter must be used with panels connected with “floating” connections, that is, with positive and negative terminals without ground connections. An advanced ground fault protection circuit continuously monitors the ground connection and disconnects the inverter when a ground fault is detected. The ground fault condition is indicated by a red LED on the front panel.

3 Installation

3.1 Installation Process

Figure3-1 Installation flowchart

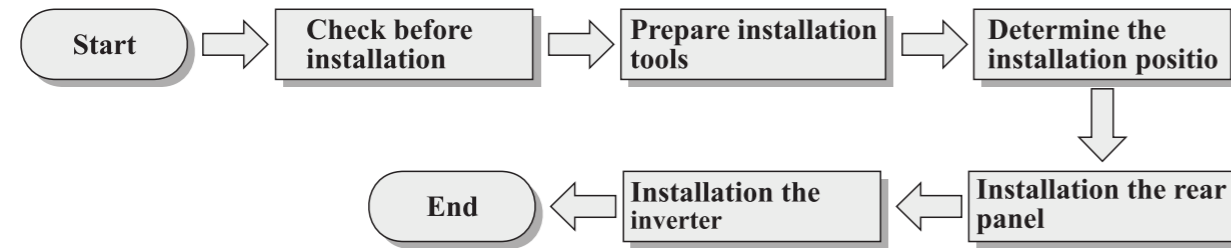

3.2 Checking Before Installation

Checking Outer Packing Materials

Packing materials and components may be damaged during transportation. Therefore, check the outer packing materials before installing the inverter. Checking the surface of packing materials for damage, such as holes and cracks. If any damage is found, do not unpack the inverter and contact the dealer as soon as possible. You are advised to remove the packing materials within 24 hours before installing the inverter.

Checking Deliverables

After unpacking the inverter, check whether deliverables are intact and complete. If any damage is found or any component is missed, contact the dealer.

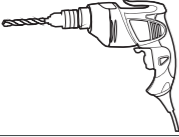
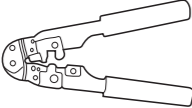
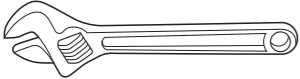

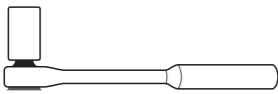

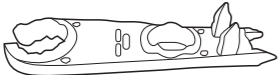

Table3-1 shows the components and mechanical parts that should be delivered





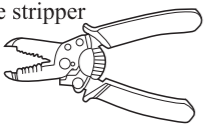

No.	Pictures	Quantity	Description
1		1PCS	Sofar 3.3K ~ 12KTL-X
2		1PCS	Rear panel
3		2PCS	DC+ input terminal
4		2PCS	DC- input terminal
5		2PCS	Metal terminals secured to DC+ input power cables
6		2PCS	Metal terminals secured to DC- input power cables
7		3PCS	M4 Hexagon screws
8		6PCS	M8*80 Expansion bolts used to secure the rear panel to the wall
9		1PCS	Manual
10		1PCS	The warranty card
11		1PCS	Certificate
12		1PCS	AC Output connector

3.3 Tools

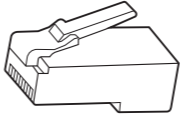
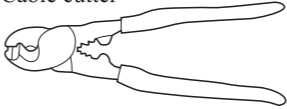
Prepare tools required for installation and electrical connections.

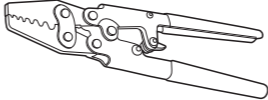
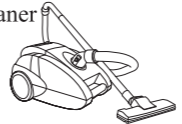
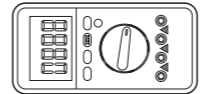
Table3-2 Shows the components and mechanical parts that should be delivered

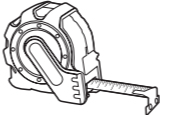
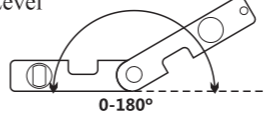
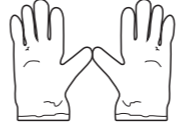
Tool	Model	Function
Hammer drill 	With a drill bit of $\Phi 8.0$	Used to drill holes on the wall
RJ45 crimping tool 	N/A	Used to prepare RJ45 connectors for Communications cables
Adjustable wrench 	With an open end of larger than or greater than 32 mm	Used to tighten expansion bolts
Flat-head screwdriver 	M4	<ul style="list-style-type: none"> Used to tighten or loosen screws when installing AC power cables. Used to remove AC connectors from the Sofar 3.3K ~ 12KTL-X. Note: The torque screwdriver and flat-head screwdriver are alternative.
Socket wrench 	M5	Used to tighten ground bolts
Rubber mallet 	N/A	Used to hammer expansion bolts into holes
Removal tool 	N/A	Used to remove DC connectors from the Sofar 3.3K ~ 12KTL-X
Diagonal pliers 	N/A	Used to cut and tighten cable ties
Wire stripper 	N/A	Used to peel cable jackets

Tool	Model	Function
	RJ45	2PCS
Cable cutter 	N/A	Used to cut power cables
Hexagon socket 	Diameter 2.0mm Diameter 5.0mm	Hexagon socket use to uninstall and install the front top cover and down cover.
Crimping tools 	N/A	Used to crimp power cables
Vacuum cleaner 	N/A	Used to clean up dusts after drilling holes
Multimeter 	N/A	Used to check grounding
Marker 	N/A	Used to mark signs
Measuring tape 	N/A	Used to measure distances
Level 	N/A	Used to ensure that the rear panel is properly installed
ESD gloves 	N/A	Operators wear ESD gloves when installing equipment.
Safety goggles 	N/A	Punch operator wearing
Anti-dust respirator 	N/A	Punch operator wearing

3.4 Determining the Installation Position

Determine an appropriate position for installing the Sofar 3.3K~12KTL-X. Comply with the following requirements when determining the installation position:

Figure 3-2 Installation position requirements

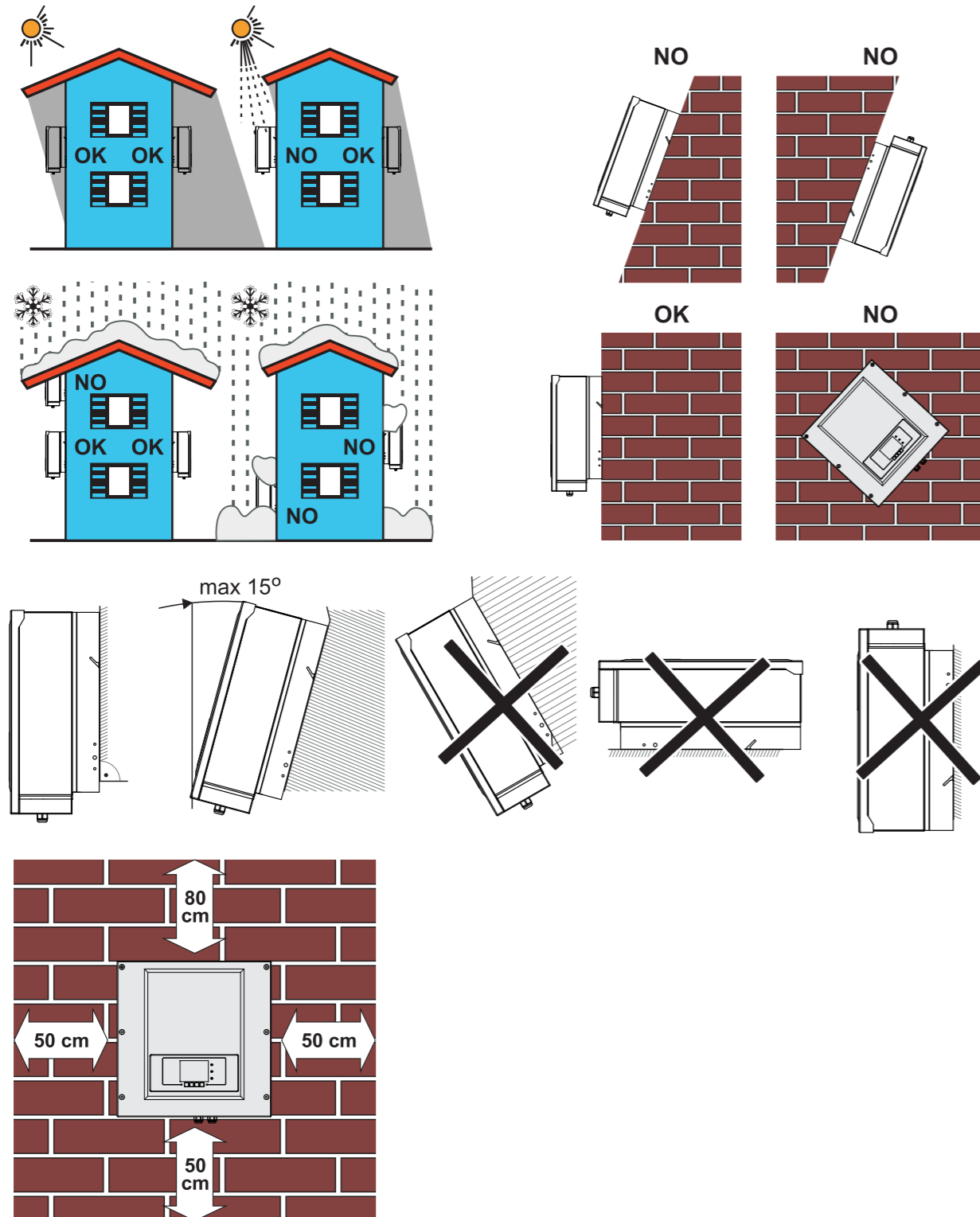

Minimum installation distance for Sofar 3.3K~12KTL-X

Figure 3-3 Many Sofar 3.3K~12KTL-X installation

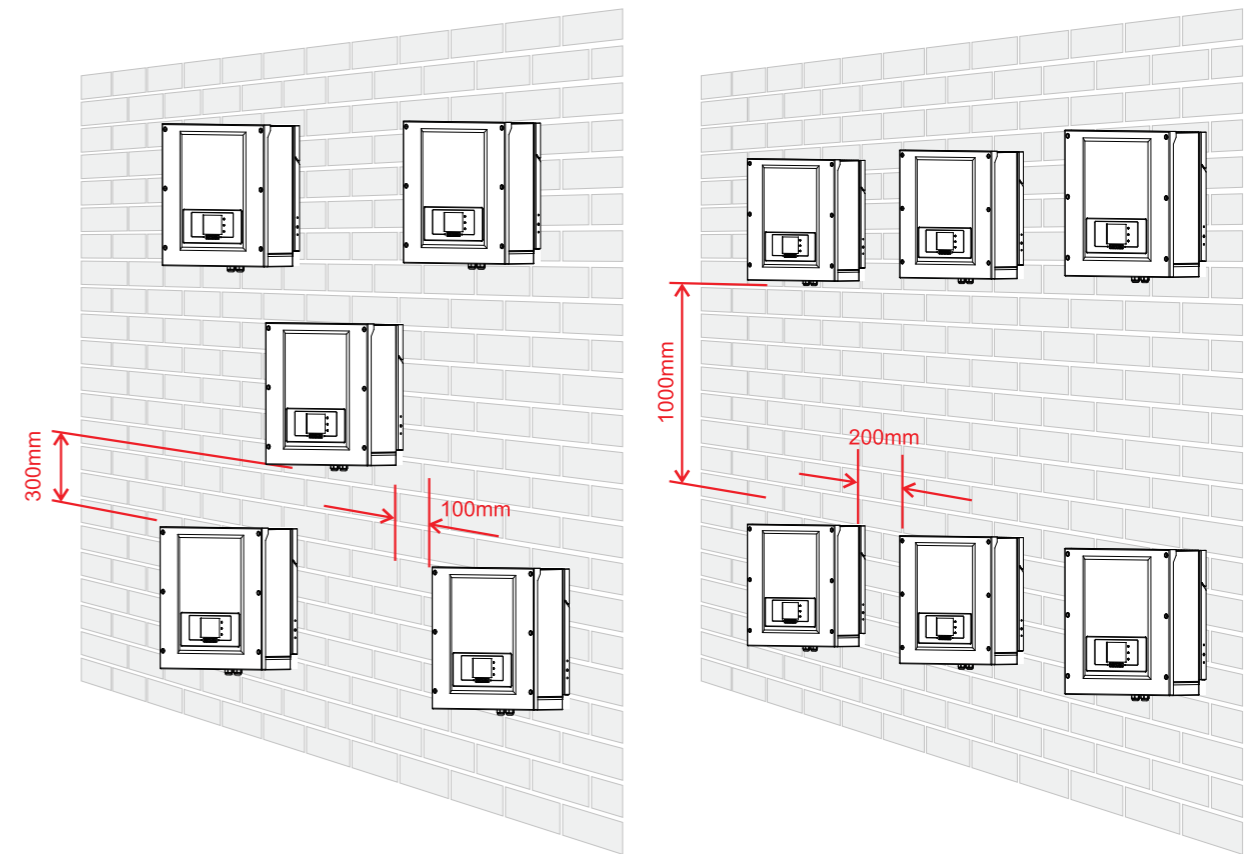

3.5 Installing the Sofar 3.3K~12KTL-X

Step 1 To determine the position for drilling holes, level hole positions, and then mark the hole position by using a marker, use the hammer drill to drill hole on the wall. Keeping the hammer perpendicular to the wall, do not shake when drilling, so as not to damage the walls. If the aperture errors, need to reposition.

Step 2 The expansion screw is vertically inserted into the hole, pay attention to expanding screw insertion depth (not too shallow).

Step 3 Putting the rear panel on the wall, the rear panel is fixed by the nuts.

Step 4 Putting the Sofar 3.3K~12KTL-X hook on the rear panel.

Step 5 Using an M6 screw back and inverter bottom fastening, to ensure safety.

Step 6 Putting the rear panel and inverter to lock together, In order to ensure the safety (the user can select lock according to the actual situation).

Figure 3-4

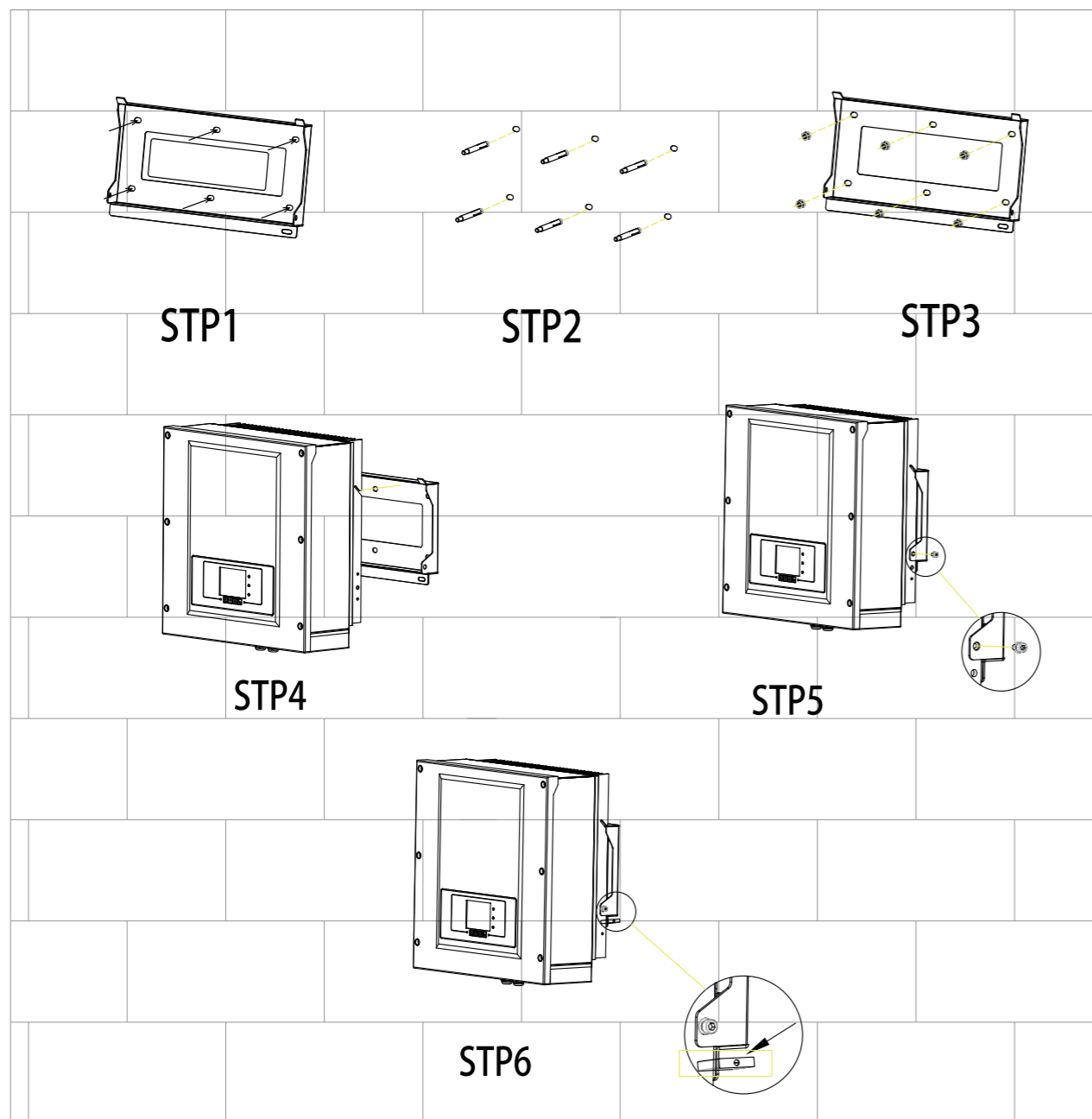

4 Electrical Connections

4.1 Electrical connection

Figure4-1 Shows the flowchart for connecting cables to the Sofar 3.3K~12KTL-X.

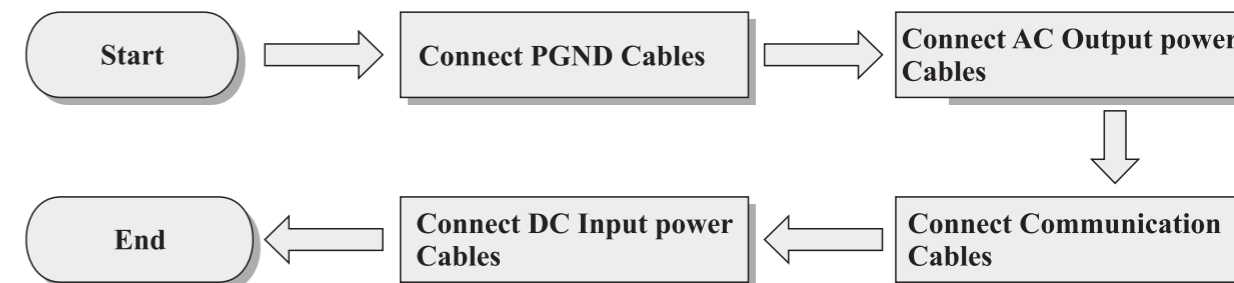

4.2 Connecting PGND Cables

Connect the Sofar 3.3K~12KTL-X to the grounding electrode using protection ground (PGND) cables for grounding purposes.

	<p>The inverter is transformerless, Requires The positive pole and the negative pole of the PV array are not grounded, Otherwise it will cause inverter failure, In the PV power generation system, all non current carrying metal parts(such as: Bracket, inverter shell) should be connected to earth.</p>
<p>Attention</p>	

Note:

- Good grounding for the Sofar 3.3K~12KTL-X can help resist the impact of the surge voltage and improve the EMI performance. First connect the PGND cable before connecting the AC power cable, DC power cable, and communication cable.
For the system with one Sofar 3.3K~12KTL-X, connect the PGND cable to the ground. For the system with multiple Sofar 3.3K~12KTL-X, connect the PGND cables of all Sofar 3.3K~12KTL-X to the grounding electrode using equipotential bonding.
- If the installation location is near the ground, first connect the PGND cable to the ground before installing the Sofar 3.3K~12KTL-X on the wall.

Figure4-2 Ground terminal composition

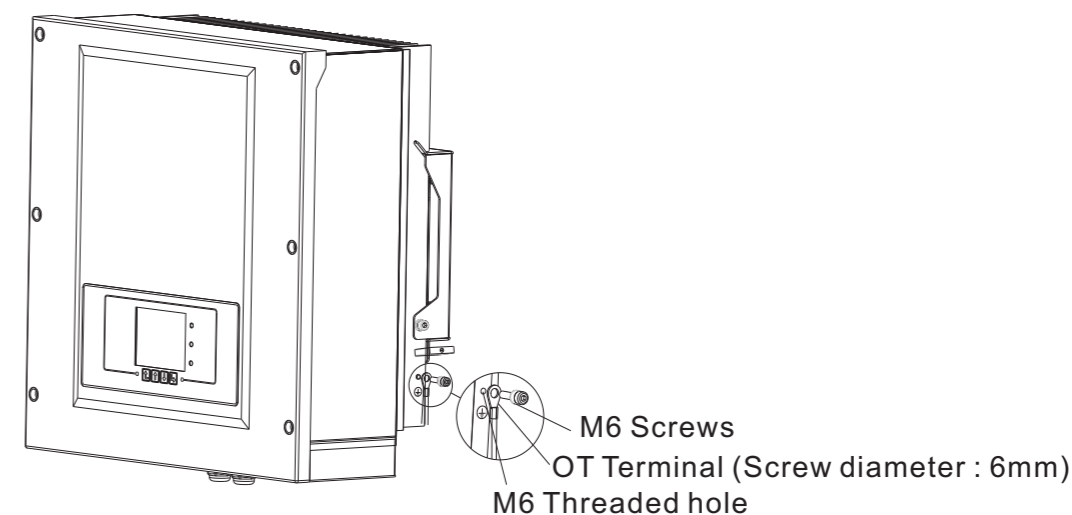

4.3 Connecting AC Output Power Cables

Connect the Sofar 3.3K~12KTL-X to the AC power distribution frame (PDF) or electrical grid using AC output power cables.

 Caution	<ul style="list-style-type: none"> It is not allowed for several inverters to use the same circuit breaker. It is not allowed to connect loads between inverter and circuit breaker.
---	--

Context

All the AC output cables used for the inverters are outdoor five-core cables. To facilitate the installation, use flexible cables. Table 4-1 lists the recommended specifications for the cables and the breakers.

Table4-1

Type	Sofar 3.3KTL-X	Sofar 4.4KTL-X	Sofar 5.5KTL-X	Sofar 6.6KTL-X	Sofar 8.8KTL-X	Sofar 11KTL-X	Sofar 12KTL-X
Cable(Copper)	2.5-6mm ²	2.5-6mm ²	2.5-6mm ²	2.5-6mm ²	4-6mm ²	4-6mm ²	4-6mm ²
Breaker	10A	10A	10A	16A	16A	20A	25A

Note: For the sake of safety, please make sure to use correctly sized cables, otherwise the current makes the cable overheat or overload, even cause a fire.

Multi core copper wire

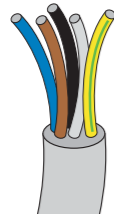

The cross-section of the AC line conductor must be sized in order to prevent unwanted disconnections of the inverter from the grid due to high impedance of the line that connects the inverter to the power supply point; In fact, if the impedance is too high, it causes an increase in the AC voltage that, on reaching the limit set by the country of installation, causes the inverter to switch off Table4-2.

Table4-2

The cable cross-sectional area(mm ²)	The maximum length(m)						
	Sofar 3.3KTL-X	Sofar 4.4KTL-X	Sofar 5.5KTL-X	Sofar 6.6KTL-X	Sofar 8.8KTL-X	Sofar 11KTL-X	Sofar 12KTL-X
2.5	50	50	40	33	/	/	/
4	80	80	60	50	40	32	26
6	120	120	96	80	60	48	40

Procedure

Sofar 3.3K~12KTL-X is a three-phase output inverter, strictly comply with local grid-connection requirements and safety standards.

Step 1 Remove the insulation layer of an appropriate length according to figure 4-3, then insert the AC output cable though the PG waterproof cable gland.

Figure4-3 AC Output Cable schematic diagram

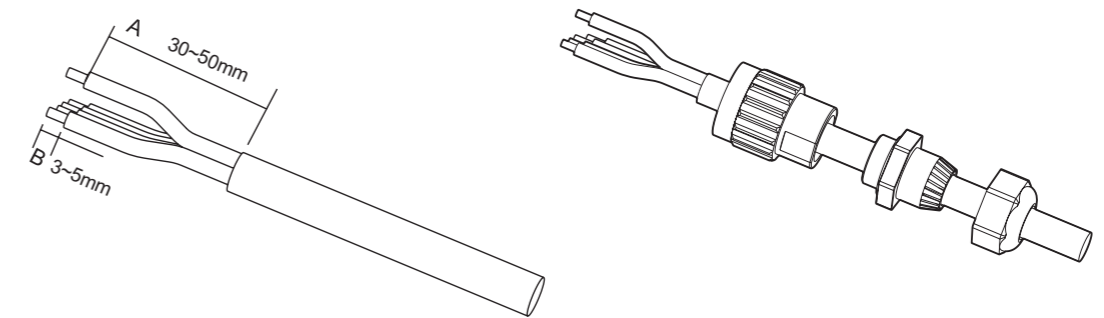

Step 2 Connecting the AC output power cable: The AC output cable(R,S,T,N and PE) is connected to the terminal block, as shown in figure 4-4.

Figure4-4 Cable connection schematic diagram

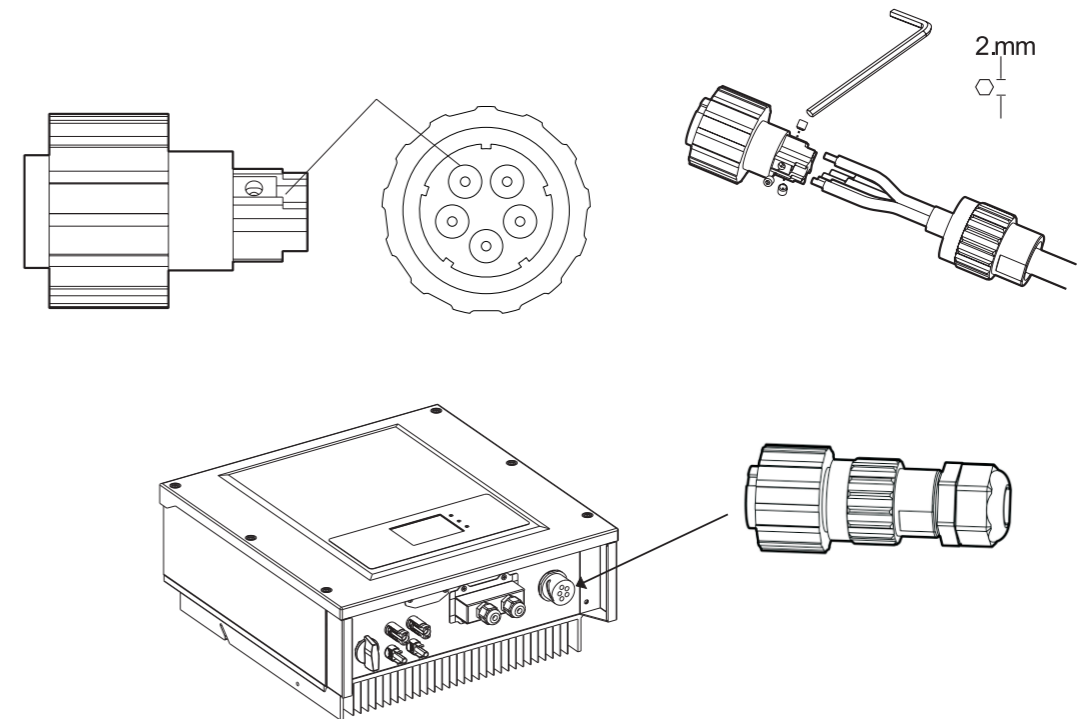

4.4 Connecting Communications Cables

Connecting Communications Port

Sofar 3.3K~12KTL-X has two communication interface, RS485 interface, WIFI interface, as shown in the following figure:

Figure 4-5 WIFI/RS485 location map

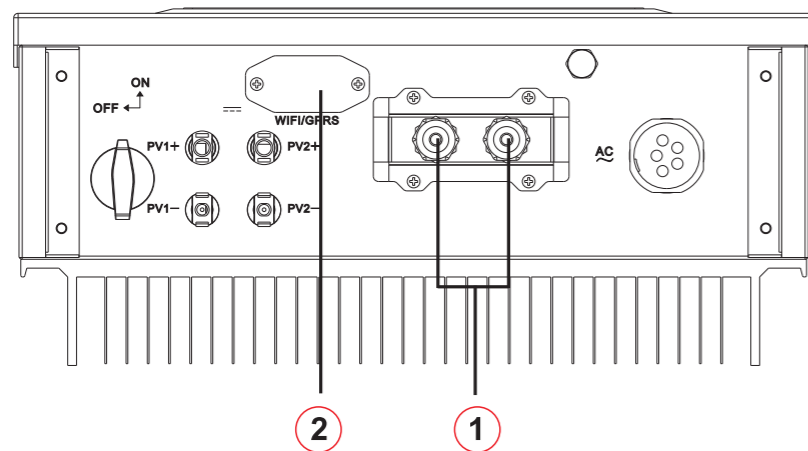

1. RS485 interface 2. WiFi/GPRS

Connecting RS485 Communications Cables

By the RS485 communication line, connecting Sofar 3.3K~12KTL-X to communication equipment (such as data acquisition, PC terminal).

You are recommended to use 24 AWG outdoor shielded network cables with the internal resistance less than or equal to 1.5 ohms/10 m and external diameter of 4.5 mm to 7.5 mm as RS485 communications cables.

A waterproof RJ45 connector has six parts: plug, screw nut, seals, housing, sealing plug and cable screw nut, as shown as follow.

Figure 4-6 Waterproof RJ45 connector composition

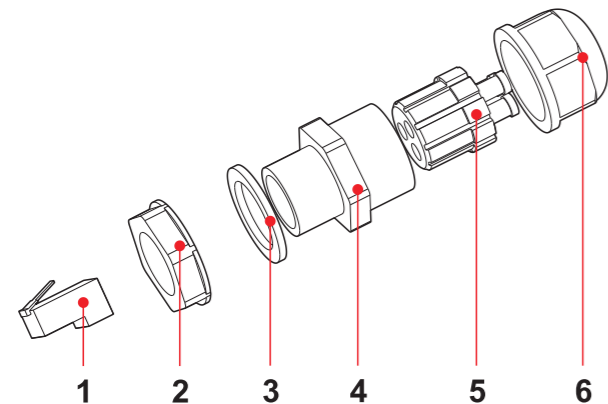

1. Plug 2. Screw nut 3. Seals 4. Housing 5. Sealing Plug 6. Cable Screw nut

When routing communications cables, ensure that communications cables are separated from power cables and away from interference sources to prevent communication interruptions.

Procedure

Step 1 Remove the insulation layer of an appropriate length from the shielded network cable using a wire stripper.

Step 2 Open Sofar 3.3K~12KTL-X lower cover and insert the shielded network cable into the cable screw nut, seals, screw nut.

Step 3 Connect the stripped network cable to corresponding pins on the plug, as shown as follow.

Figure 4-7 RS485 Connecting Communications Cables(1)

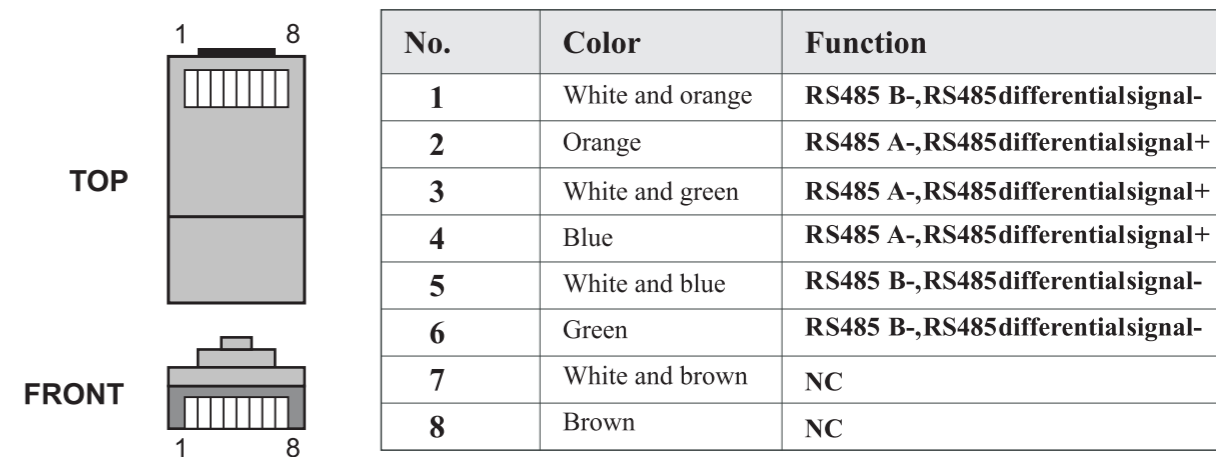
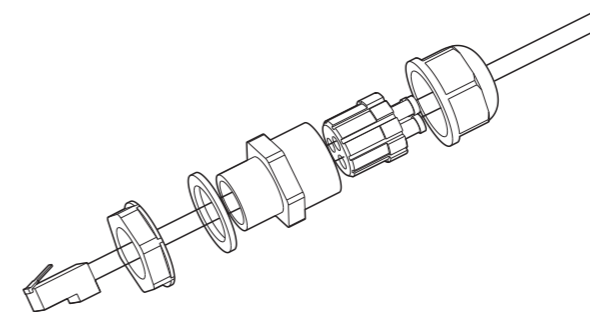

Figure 4-8 RS485 Connecting Communications Cables(2)



Step 4 Crystal plug with RJ45 crimping tool.

Step 5 Insert the plug into the RS485 port on the Sofar 3.3K~12KTL-X.

Step 6 Insert sealing plug into housing.

Figure 4-9 RS485 Connecting Communications Cables(3)

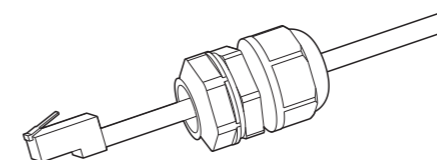

Communications Port Description

This topic describes the functions of the RS485 and WIFI ports.

RS485

By RS485 interface, transfer the inverter power output information, alarm information, operation state to the PC terminal or local data acquisition device, then uploaded to the server (such as TERMINAL).

1. USB-RS485

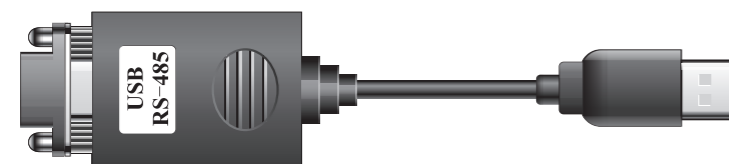

2. TERMINAL

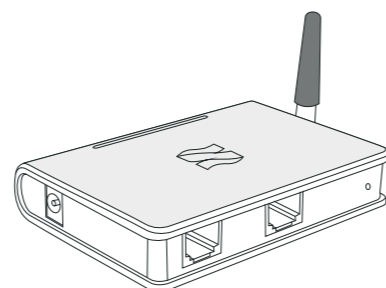

If only one Sofar 3.3K~12KTL-X is used, use a communication cable with waterproof RJ45 connectors, and choose either of the two RS485 ports.

Figure 4-10 A single Sofar 3.3K~12KTL-X connecting Communications

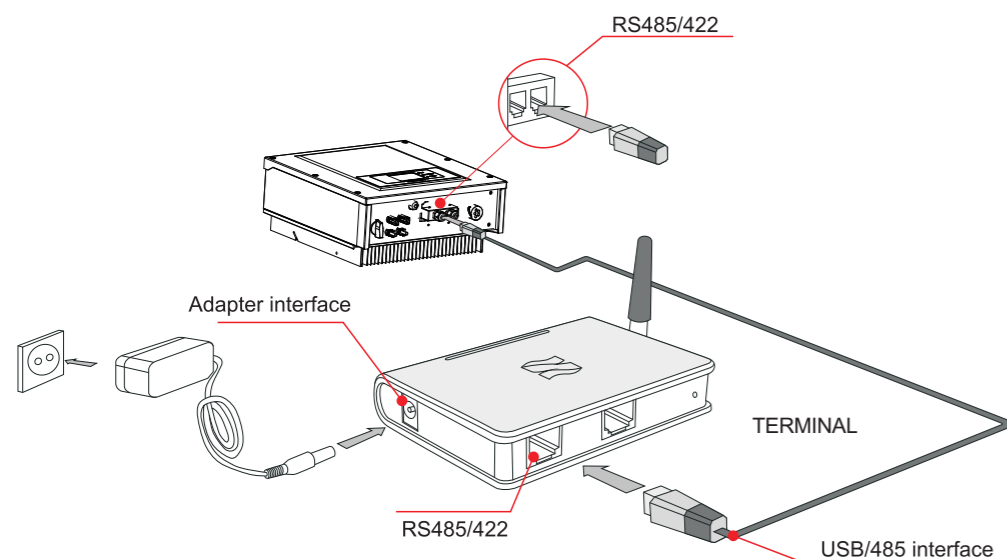

If multiple Sofar 3.3K~12KTL-X are used, connect all Sofar 3.3K~12KTL-X in daisy chain mode over the RS485 communication cable.

Figure 4-11 Multi Sofar 3.3K~12KTL-X connecting Communications

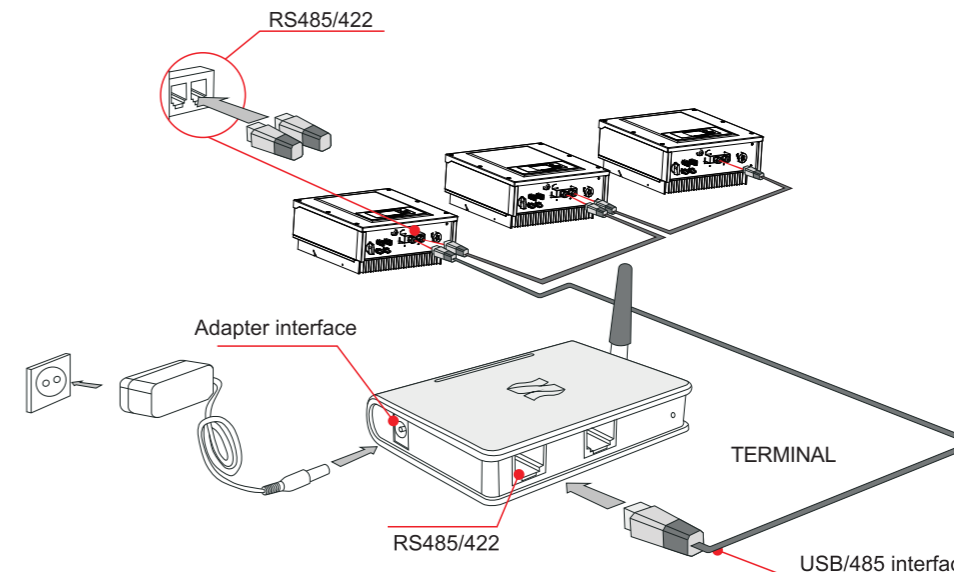

According to the manufacturers to provide SN number can register remote monitoring of Sofar 3.3K~12KTL-X through <http://www.solarmanpv.com/portal/LoginPage.aspx>. or <http://solar.eybond.com>

WiFi/GPRS

By the WIFI interface, transfer the inverter power output information, alarm information, operation state to the PC terminal or local data acquisition device, then uploaded to the server (such as TERMINAL).

According to the manufacturers to provide SN number can register remote monitoring of Sofar 3.3K~12KTL-X through <http://www.solarmanpv.com/portal/LoginPage.aspx>. or <http://solar.eybond.com>

Figure 4-12 Connect multiple Wifi to wireless router

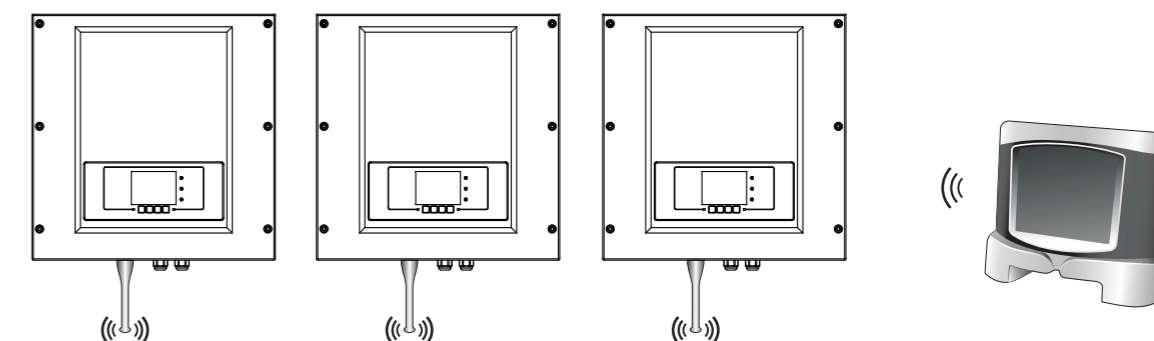

Note

- The length of the RS485 communication cable should be less than 1000 m.
- The length of the Wifi communication cable should be less than 100 m.
- If multiple Sofar 3.3K~12KTL-X are connected to the monitoring device over an RS485/RS232 converter, a maximum of 31 inverter can be connected in a daisy chain.
- If multiple Sofar 3.3K~12KTL-X are connected to a TERMINAL, a maximum of 31 Sofar 3.3K~12KTL-X can be connected in three daisy chains.

Connecting to DRED(Demand Response Enabling Device) ----only Australia

Step1: Open the bottom cover, the wire through the waterproof joint and locks the terminal

Step2: Insert the terminal and lock the screw

Step3: Refer to "6.3 main interface "setting to enable the function

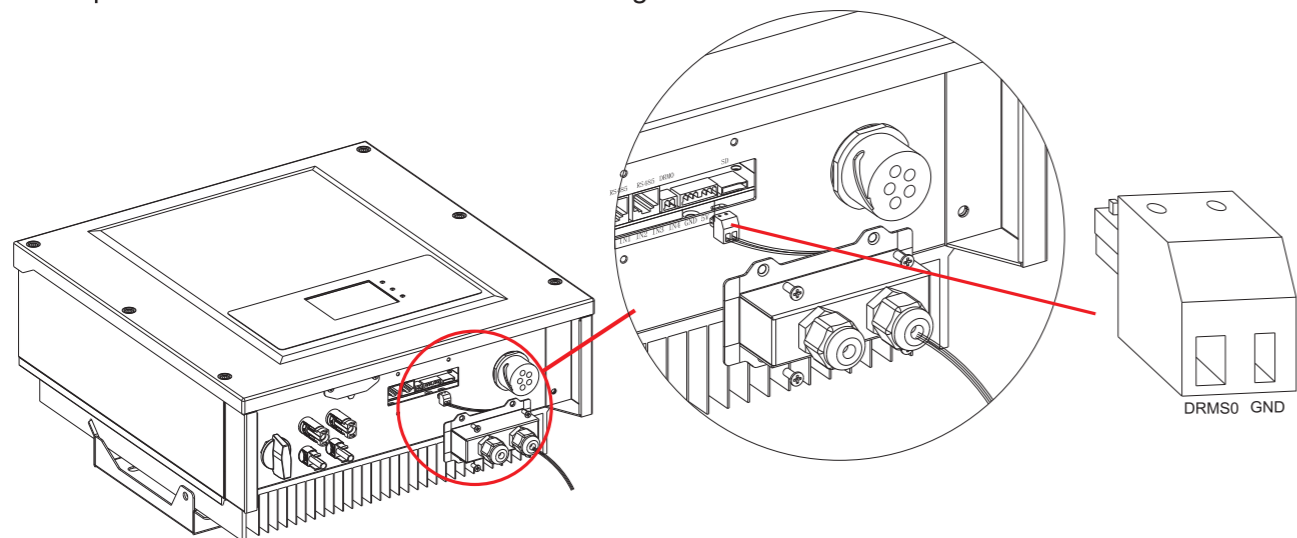

4.5 Connecting DC Input Power Cables

Connect the Sofar 3.3K~12KTL-X to PV arrays over DC input power cables.

Input mode selection : Sofar 3.3K~12KTL-X has 2 MPPT, The two MPPT can run independently, but also can be operated in parallel, According to the system design, the user can choose the mode of MPPT operation.

Independent mode (default):

If the two MPPT panels is independent, the input mode should be set as "independent mode".

The setting method is introduced at chapter 6.3.

Parallel mode :

If the two MPPT panels is paralleled together by combiner, the input mode should be set as "parallel mode".

The setting method is introduced at chapter 6.3.



Note

According to the inverter type, choose the inverter accessories (cables, fuse holder, fuse, breaker etc.), Sofar inverter with PV array should be excellent performance, reliable quality. The open circuit voltage of PV must be less than Maximum DC input voltage of Sofar inverter, The output voltage of the solar array must be consistent with the MPPT voltage range.

The positive and negative poles of the panel to inverter need to connect fuse separately. The electric wire should choose PV cable, from the junction box to the inverter, line voltage drop is about 1~2%, The inverter is installed in the PV bracket, which saves the cable and reduce the DC loss.



Note

- Check polarity of PV array, to ensure the correct wiring of PV array;
- Please don't put the positive or negative of the PV array connect to earth.



Danger

- PV modules generate electric energy when exposed to sunlight and can create an electrical shock hazard. Therefore, when connecting DC input power cable, cover PV modules by using opaque cloth.
- Before performing electrical connections, ensure that voltages of the DC cables should be within the safe voltage range, that is, lower than 60 V DC, and the DC SWITCH is OFF. Otherwise, the high voltage may result in fatal danger.



Caution

Ensure that the following conditions are met. Otherwise, fire accident may occur.

- PV modules connected in series in each PV array are of the same specifications.
- The open-circuit voltage of each PV array is always lower than or equal to 1000 V DC.
- The output power of each PV array is always less than or equal to the maximum input power of the Sofar 3.3K~12KTL-X.
- The positive and negative terminals of PV arrays connect to the positive and negative DC input terminals respectively.

Context

Table 4-3 Recommended DC input cable specifications

Cross-Sectional Area (mm)		External Cable Diameter(mm)
Range	Recommended Value	
4.0~6.0	4.0	4.5~7.8

DC input connectors are classified into positive and negative connectors, as shown in Figure 4-13 and Figure 4-15.

Figure 4-13 Positive connector composition

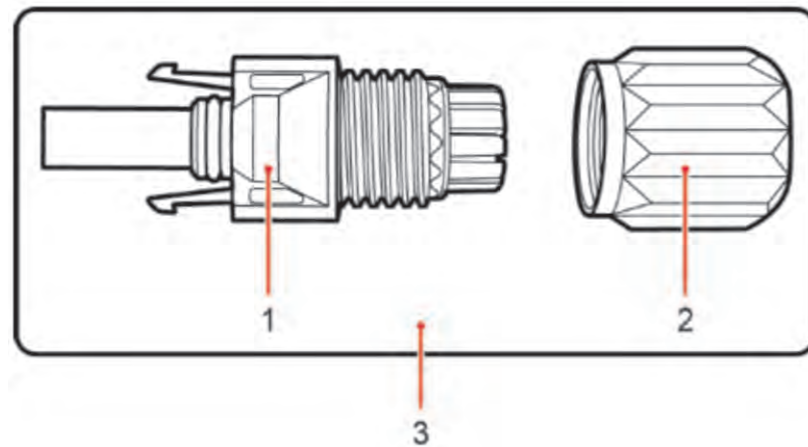

1. Housing 2. Cable gland 3. Positive connector

Figure 4-14 Negative connector composition

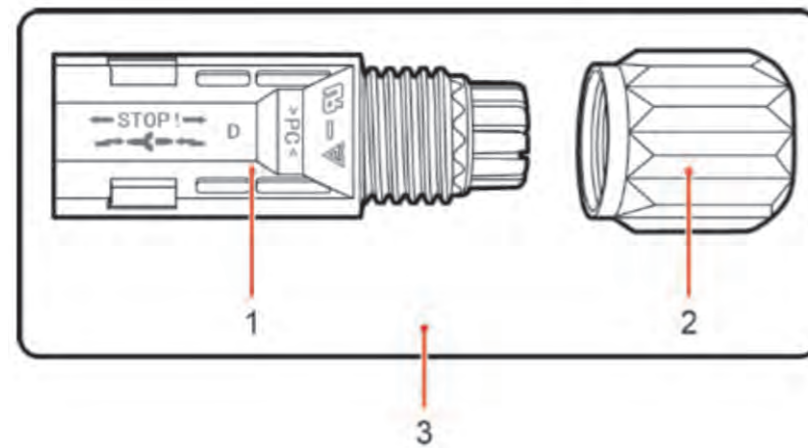

1. Housing 2. Cable gland 3. Negative connector



Note

Positive and negative metal terminals are packed with positive and negative connectors respectively. Separate the positive from negative metal terminals after unpacking the Sofar 3.3K~12KTL-X to avoid confusing the polarities.

Procedure

Step 1 Remove cable glands from the positive and negative connectors.

Step 2 Remove the insulation layer with an appropriate length from the positive and negative power cables by using a wire stripper as show in Figure 4-16.

Figure 4-15 Connecting DC input power cables

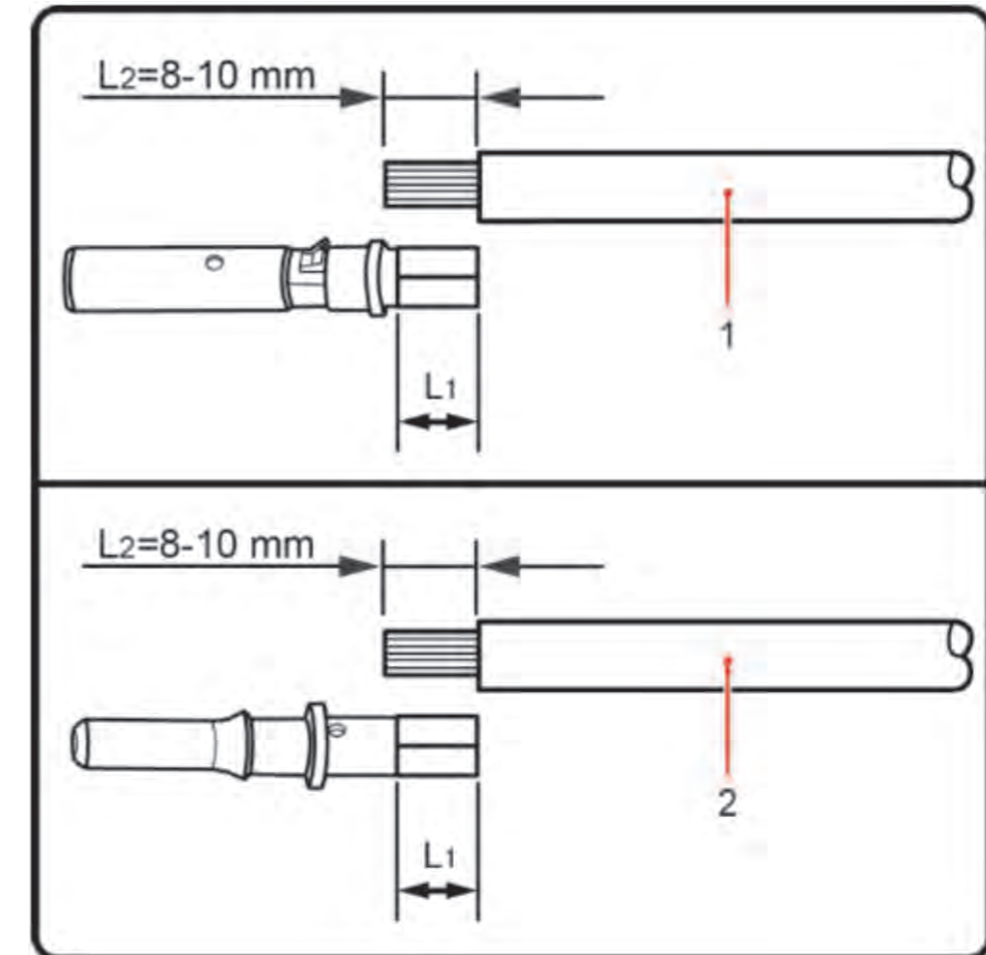

1. Positive power cable 2. Negative power cable



Note

L2 is 2 to 3 mm longer than L1.

Step 3 Insert the positive and negative power cables into corresponding cable glands.

Step 4 Insert the stripped positive and negative power cables into the positive and negative metal terminals respectively and crimp them using a crimping tool. Ensure that the cables are crimped until they cannot be pulled out by force less than 400 N, as shown in Figure 4-17.

Figure 4-16 Connecting DC input power cables

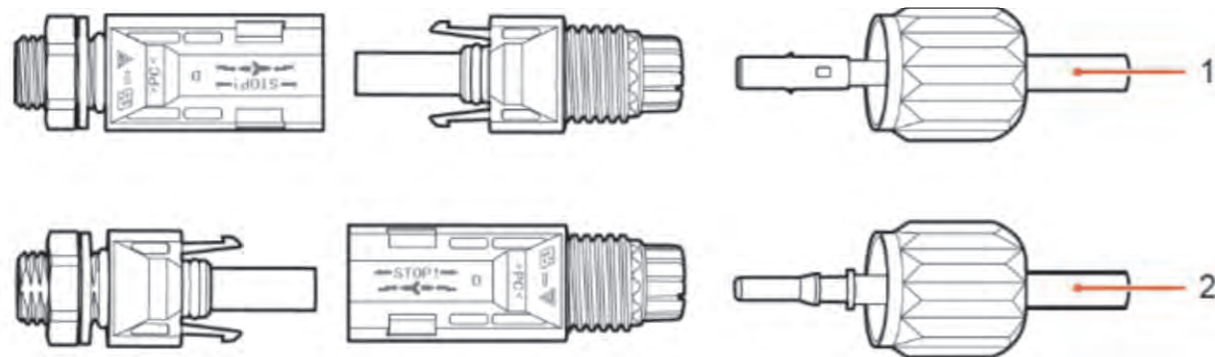

1. Positive power cable 2. Negative power cable

Step 5 Insert crimped power cables into corresponding housings until you hear a "click" sound. The power cables snap into place.

Step 6 Reinstall cable glands on positive and negative connectors and rotate them against the insulation covers.

Step 7 Insert the positive and negative connectors into corresponding DC input terminals of the Sofar 3.3K~12KTL-X until you hear a "click" sound, as shown in Figure 4-17.

Figure 4-17 Connecting DC input power cables

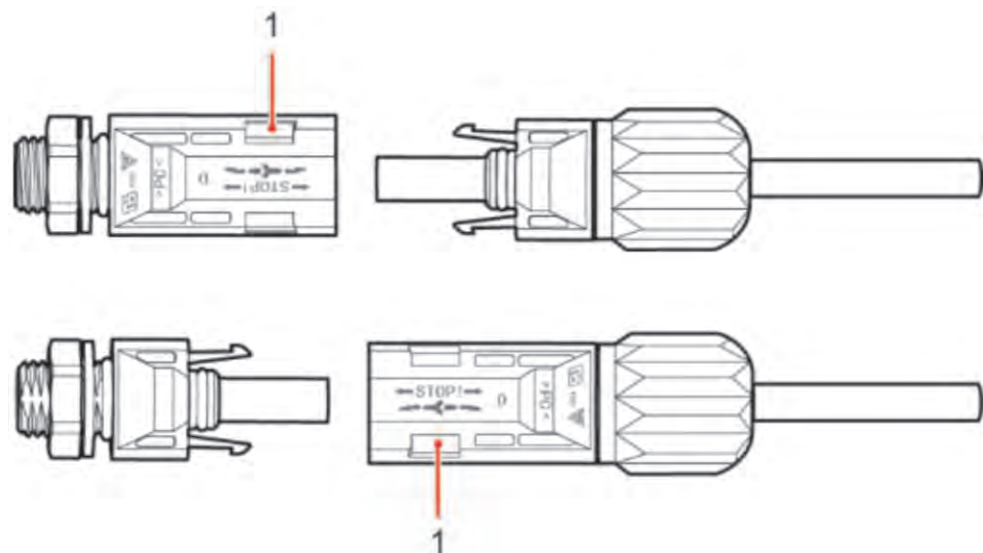

— — — End

Follow-up Procedure

To remove the positive and negative connectors from the Sofar 3.3K~12KTL-X, insert a removal wrench into the bayonet and press the wrench with an appropriate strength, as shown in Figure 4-18.

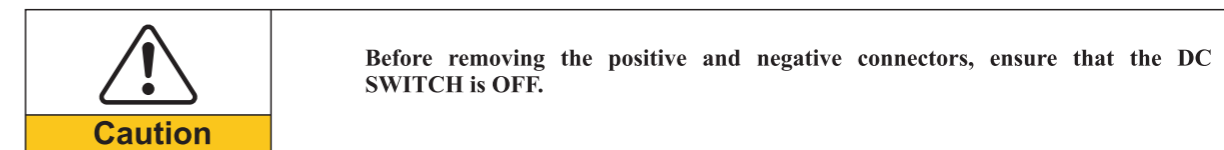
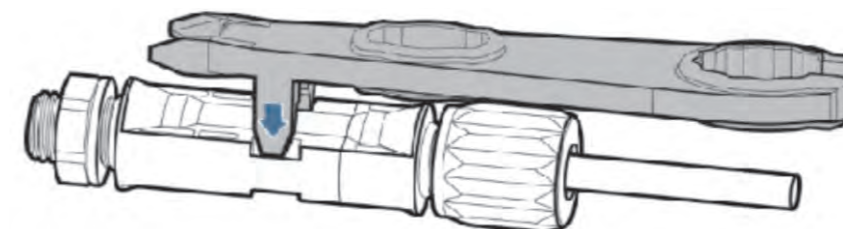

Figure 4-18 Removing a DC input connector



4.6 Safety check

• Photovoltaic array

Before the inverter operation, need to be examined for the photovoltaic array, Check Open circuit voltage of the each PV array whether accord with the requirements.

- Ensure Open circuit voltage of the each PV array accord with the requirements;
- Ensure that the positive and negative polarity is correct.

• Sofar 3.3K~12KTL-X DC connect

Use the multimeter to check the DC side voltage and current;

Check the DC cable, Note the positive and negative poles cannot be reversed, Consistent with the positive and negative pole of photovoltaic array, measured each input Open circuit voltage

Compare the voltage, if the difference is greater than 3%, PV array line may be a fault

• Sofar 3.3K~12KTL-X AC connect

Ensure the AC breaker of the inverter is off

Check the inverter phase with grid is connected properly, Check the voltage of each phase is within a predetermined range, if possible, Measure the THD, If the distortion is serious, the inverter may not work.

5 Commissioning of inverter

5.1 Safety inspection before commissioning

 Attention	<p>Ensure that DC and AC voltages are within the range permitted by the inverter.</p>
---	---

5.2 Start inverter

Step 1 Turn on DC switch.

Step 2 Turn on AC switch.

When the solar arrays generate adequate power, the inverter will startup automatically. Display showing “normal” indicates correct operation.

Step 3: Choose the correct country code. (refer to section 6.3 of this manual)

Notice: Different distribution network operators in different countries have different requirements regarding grid connections of PV grid connected inverters.

Therefore, it's very important to make sure that you have selected the correct country code according to requirements of local authority.

Please consult qualified electrical engineer or personnel from electrical safety authorities about this.

Shenzhen SOFARSOLAR Co., Ltd. is not responsible for any consequences arising out of incorrect country code selection.

If the inverter indicates any other fault, please refer to part 7—error messages for help.



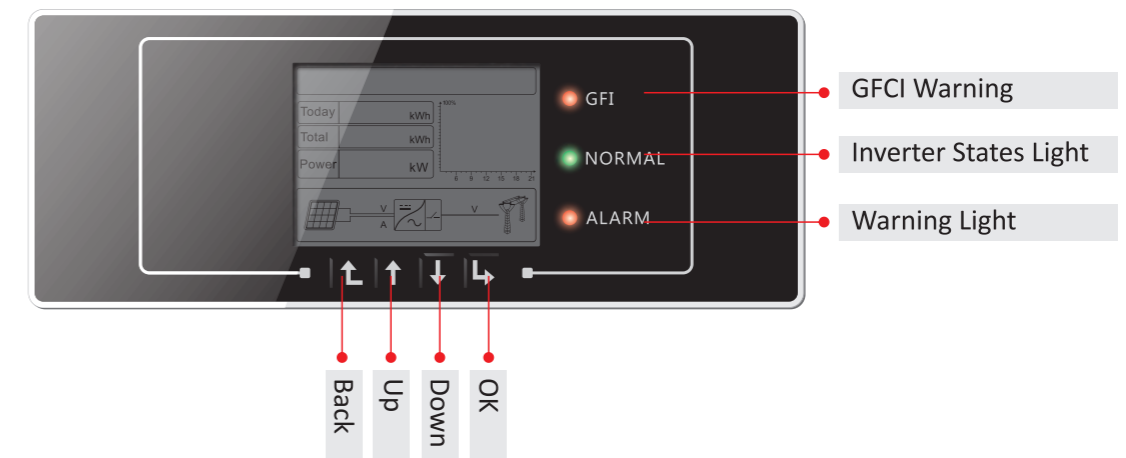

6 Operation interface

6.1 Operation and Display Panel

- Buttons and Indicator lights



Key-button:

- Back : to back up or enter into main interface at standard interface states
- Up : to move up or increase value
- Down : to move down or decrease value
- Enter : to confirm selection

Indicator Lights:

- States Light(GREEN)
 - Flashing: Waiting or checking state
 - ON: Normal operation
 - OFF: Fault or permanent state
- Warning Light (RED)
 - Flashing: Fans fault
 - ON: The inverter is faulty
 - OFF: Normal operation
- GFCI Warning Light (RED)
 - ON: GFCI fault
 - OFF: GFCI normal

6.2 Standard Interface

LCD standard interface is used to display inverter states, information and parameter setting etc.

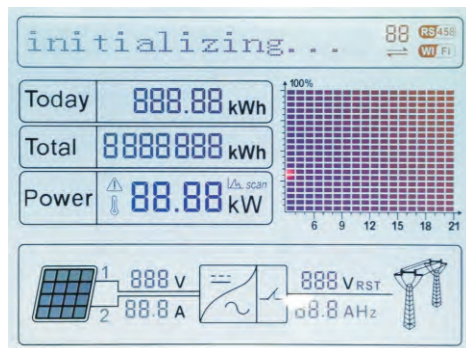

LCD displays the updates of inverter energy, power, input information, warning information etc

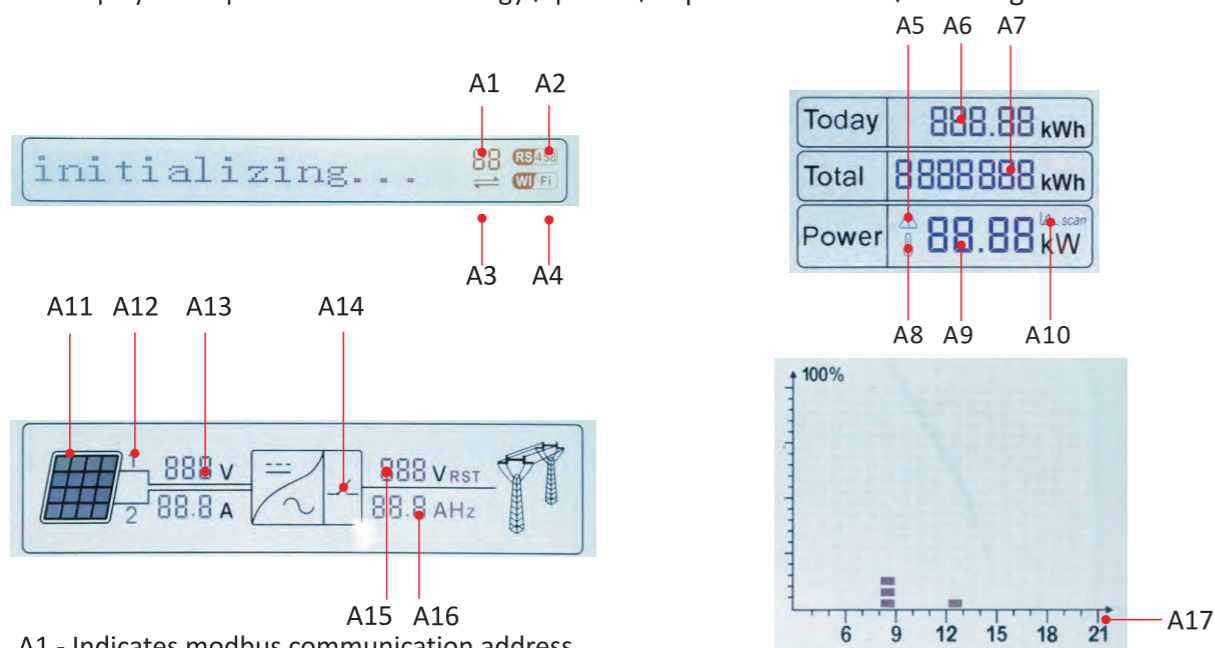

- A1 - Indicates modbus communication address.
- A2 - RS485 communicating
- A3 - Light ON for RS485 communicating
- A4 - WIFI communicating
- A5 - Light flashes to warn over frequency and power derating. Light ON to warn remote
- A6 - Indicates today's energy
- A7 - Indicates the total energy
- A8 - Light ON warning for inverter high temperature
- A9 - Indicates real time output power
- A10 - MPPT SCAN function is activated (not available)
- A11 - Light ON when input voltage over 160V
- A12 - Indicates real time input voltage and current channel
- A13 - Indicates the input voltage and current of phase 1&2 and displays in turns in every three seconds
- A14 - Light ON when the state is normal
- A15 - Indicates R/T/S phase voltage and displays in turns in every three seconds
- A16 - Indicates R/T/S phase current or frequency and displays in turns in every three seconds
- A17 - Indicates the energy from 3:00am-21:00pm in the day

When power-on, LCD interface displays INITIALIZING, refer below picture.



when control board successfully connected with communication board, the LCD display the current state of the inverter, display as shown in the figure below.

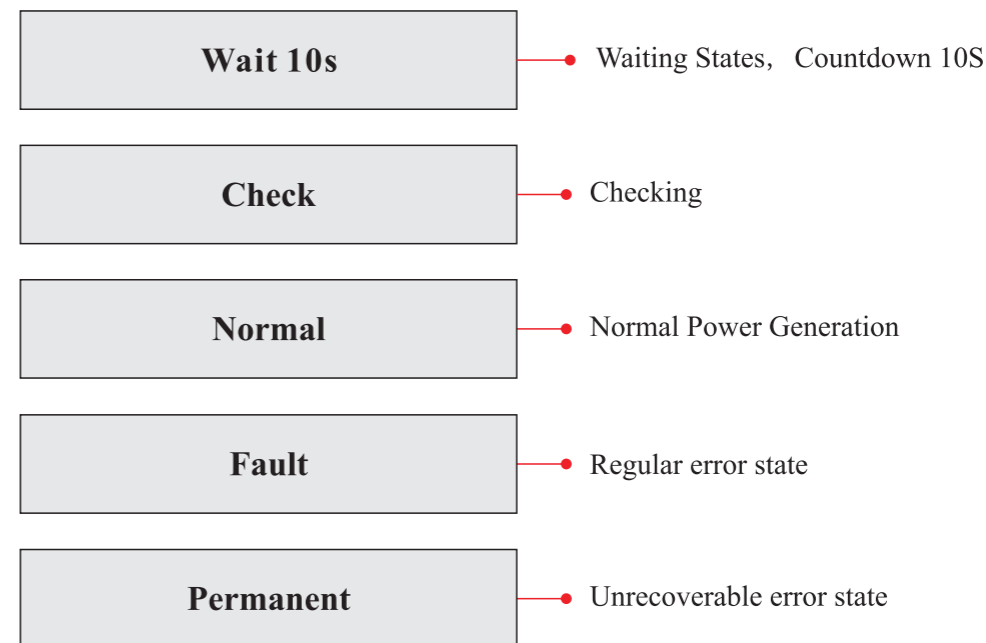

Inverter states includes: wait, check, normal, fault and permanent

Wait : Inverter is waiting to Check State at the end of reconnection time. In this state, the PV voltage is more than 180V, grid voltage value is between the max and min limits and so on; If not, Inverter will go to Fault State or Permanent State.

Check: Inverter is checking isolation resistor, relays, and other safety requirements. It also does self-test to ensure inverter software and hardware are functional. Inverter will go to Fault State or Permanent State if any error or fault occurs.

Normal : Inverter enter to Normal State, it is feeding power to the grid; inverter will go to Fault State or Permanent state if any error or fault occurs.

Fault : Fault State: Inverter has encountered recoverable error. It should recover if the errors disappear. If Fault State continues; please check the inverter according error code.

Permanent : Inverter has encountered unrecoverable error, we need maintainer debug this kind of error according to error code.

When the control board and communication board connection fails, the LCD display interface as shown in the figure below.



6.3 Main Interface

Press “Back” button under standard interface to enter into main interface, including:

Normal	• Key“Back”
1. Enter Setting	
2. EventList	
3. SystemInfo	
4. System Time	
5. Software Update	

(A) “Enter Setting” Interface as below:

1.Enter Setting
1. Set time
2. Clear Energy
3. Clear Events
4. Set Country Code
5. On-Off Control
6. Enset Country
7. Set Energy
8. Set Address
9. Set Inputmode
10. Set Language
11. Set StartPara
12. Set SafetyVolt
13. Set SafetyFreq
14. Set Insulation
15. Set Reactive
16. Set PowerDerat
17. PE Linecontrol
18. Set RefluxP
19. DRMS0 Control
20. Set PowerRatio
21. Autotest Fast
22. Autotest STD

◆ **Set Time**

Users press “Back” button to enter “1.Enter Setting” interface, Press “OK” button to enter main setting interface. Enter “1. Set Time” by pressing“Up” button or “Down” button, then press”OK“button and start to set up time.

Time set from year, month, day, minutes, and seconds in turns, “Up” button or “Down”button to choose different value to set each date. Set each value is need to press “OK” button to confirm setting. “success” is displayed if the setting time is correct, “fail” means failure settings.

◆ **Clear Energy**

Users press “Back” button to enter “1.Enter Setting” interface, Press “OK” button to enter main setting interface. Then Enter “2.Clear Energy ” by pressing “Up” button or “Down” button, press “OK” button and start to clear produce. “success” is displayed after settings.

◆ **Clear Events**

Users press “Back” button to enter “1.Enter Setting” interface, Press “OK” button to enter main setting interface. Enter “3. Clear Events” by pressing “Up” button or “Down” button. Press “OK” button and start to clear events. “success” is displayed after settings.

◆ **Set Country Code**

Users press “Back” button to enter “1.Enter setting” interface, Press OK button to enter main setting interface. Enter “4.Set Country Code” by pressing “Up” button Or “Down” button, press “OK” button and enter “Input Password” Setting interface. If it's shown "set disable" on the screen, then you can NOT choose the operating country, you should enable country setting through " 6. Enset Country " interface. If it's shown "set Country code?" on the screen, then press Confirm button to start country setting. "Success" will be shown on the screen after a successful country setting.

User can check current country code in SystemInfo>>5. Country.

Note: Country code changing will take effect after inverter reboot.

Table 6-1 country code setting

code	country	code	country	code	country
00	Germany VDE AR-N4105	12	Poland	24	Cyprus
01	CEI0-21 Internal	13	Germany BDEW	25	India
02	Australia	14	Germany VDE 0126	26	Philippines
03	Spain RD1699	15	Italy CEI0-16	27	NewZealand
04	Turkey	16	UK-G83	28	Brazil
05	Denmark	17	Greece island	29	Slovakia VSD
06	Greece Continent	18	EU EN50438	30	Slovakia SSE
07	Netherland	19	IEC EN61727	31	Slovakia ZSD
08	Belgium	20	Korea	32	CEI0-21 In Areti
09	UK-G59	21	Sweden	33-49	Reserved
10	China	22	Europe General		
11	France	23	CEI0-21 External		

◆ **On-Off Control**

Users press "Back" button to enter "1.Enter Setting" interface, Press "OK" button to enter main setting interface. Enter "5.On-Off Control" by pressing "UP" button or "Down" button. Press "OK" button and enter On-Off Control interface, press "OK" button and enter "Input Password" Setting interface. Press "OK" button to set passwords (default:0001), increase or decrease value though pressing "Up" button or "Down" button, press "OK" button to next value setting. "Error! Try again" will be displayed for wrong passwords. Press "back" button and rekey in the correct passwords. It will enter into "Power on&Power off" interface if the passwords is correct, then you can select "Power on" or "Power off" by pressing "Up" button or "Down" button and press "OK" button to finish the setting successfully. If you select "Power off", need to set how many days you want the inverter to power off, increase or decrease value though pressing "Up" button or "Down" button. After you set "Power off" successfully, you need to contact manufacturer to supply passwords to re-power on this inverter.

◆ **Enset Country**

Users press “Back” button to enter “1.Enter Setting” interface, Press “OK” button to enter main setting interface. Enter “ 6. Enset Country ” by pressing “Up” button or “Down” button, press “OK” button and enter “Input Password” Setting interface.

Press “Back” button to set passwords (default: 0001), increase or decrease value though pressing “Up” button or “Down” button, press “OK” button to next value setting. “Error! Try again” will be displayed for wrong passwords. Press “Back” button and rekey in the correct passwords. “success” will be displayed if setting successfully,

Attention: when inverter working for power generation over 24h, country setting is forbidden, it can only be set after LCD setting. Key in passwords for country setting through LCD (default: 0001), country setting can be set in 24h after keying in the correct passwords, over 24h, set through LCD again.

◆ **Set Energy**

Users press “Back” button to enter “1.Enter Setting” interface, Press “OK” button to enter main setting interface. Enter “ 7. Set Energy ” by pressing “ Up ” button or “Down” button, press “OK” button and enter “Input Password” Setting interface.

Press “Back” button to set passwords (default: 0001), increase or decrease value though pressing “Up” button or “Down” button, press “OK” button to next value setting. “Error! Try again” will be displayed for wrong passwords. Press “Back” button and rekey in the correct passwords. “success” will be displayed if setting successfully,

◆ **Set Address**

Users press “Back” button to enter “1.Enter setting” interface, Press “OK” button to enter main setting interface. Enter “8. Set Address” by pressing “Up” button or “Down” button. Press “OK” button and enter setting interface “Success” or “fail” is displayed after setting.

◆ **Set Inputmode**

Input mode selection: Sofar 3.3K~12KTL-X has 2 MPPT, The two MPPT can run independently, and also can be operated in parallel, According to the system design, the user can choose the mode of MPPT operation. The input mode can be setting by the LCD .

Users press “Back” button to enter “1.Enter setting” interface, Press “OK” button to enter main setting interface. Enter “ 9. Set inputmode” by pressing “Up” button or “Down” button. Press “OK” button and enter setting interface. Choose corresponded setting items by pressing “Up” button or “Down” button, then press “OK” button. “Success” or “fail” is displayed after setting.

◆ **Set Language**

Users press "Back" button to enter "1.Enter setting" interface, Press "OK" button to enter main setting interface. Enter "10. Set Language" by pressing "Up" button or "Down" button. Press "OK" button and enter setting interface. Choose corresponded setting items by pressing "Up" button or "Down" button, then press "OK" button. "Success" or "fail" is displayed after setting.

◆ **Set StartPara**

User can change the start parameter by the LCD. First the User need to copy the .TXT file which is used to change the start parameter to the SD card .

Users press Back button to enter "1.Enter setting" interface, Press OK button to enter main setting interface. Enter "11. Set StartPara" by pressing "Up" button Or "Down" button, press "OK" button and enter "Input Password" Setting interface. Press "Back" button to set passwords (default: 0001), increase or decrease value though pressing "Up" button or "Down" button, press "OK" button to next value setting. "Error!" Try again" will be displayed for wrong passwords. Press "Back" button and rekey in the correct passwords. "Success" will be displayed if setting successfully.

◆ **Set SafetyVolt**

User can change the Voltage protection point by the LCD. First the User need to copy the .TXT file which is used to change the Voltage protection point to the SD card .

Users press Back button to enter "1.Enter setting" interface, Press OK button to enter main setting interface. Enter "12. Set SafetyVolt" by pressing "Up" button Or "Down" button, press "OK" button and enter "Input Password" Setting interface. Press "Back" button to set passwords (default: 0001), increase or decrease value though pressing "Up" button or "Down" button, press "OK" button to next value setting. "Error!" Try again" will be displayed for wrong passwords. Press "Back" button and rekey in the correct passwords. "Success" will be displayed if setting successfully.

◆ **Set SafetyFreq**

User can change the Frequency protection point by the LCD. First the User need to copy the .TXT file which is used to change the Frequency protection point to the SD card .

Users press Back button to enter "1.Enter setting" interface, Press OK button to enter main setting interface. Enter "13. Set SafetyFreq" by pressing "Up" button Or "Down" button, press "OK" button and enter "Input Password" Setting interface. Press "Back" button to set passwords (default: 0001), increase or decrease value though pressing "Up" button or "Down" button, press "OK" button to next value setting. "Error!" Try again" will be displayed for wrong passwords. Press "Back" button and rekey in the correct passwords. "Success" will be displayed if setting successfully.

◆ **Set Insulation**

User can change the Insulation protection point by the LCD. First the User need to copy the .TXT file which is used to change the Insulation protection point to the SD card .

Users press Back button to enter "1.Enter setting" interface, Press OK button to enter main setting interface. Enter "14. Set Insulation" by pressing "Up" button Or "Down" button, press "OK" button and enter "Input Password" Setting interface. Press "Back" button to set passwords (default: 0001), increase or decrease value though pressing "Up" button or "Down" button, press "OK" button to next value setting. "Error!" Try again" will be displayed for wrong passwords. Press "Back" button and rekey in the correct passwords. "Success" will be displayed if setting successfully.

◆ **Set RefluxP**

Users press "Back" button to enter "1.Enter Setting" interface, Press "OK" button to enter main setting interface. Enter "18. Set RefluxP" by pressing "Up" button or "Down" button, press "OK" button and enter "Input Password" Setting interface. Press "OK" button to set passwords (default:0001), increase or decrease value though pressing "Up" button or "Down" button, press "OK" button to next value setting. "Error! Try again" will be displayed for wrong passwords. Press "back" button and rekey in the correct passwords. Then select "Reflux Enable" or "Reflux Disable" by pressing "Up" and "Down" button. "success" will be displayed if setting successfully.

◆ **DRMS0 Control(only Australia)**

Enable the function to refer "4.4 Connecting communication cables"connection DRED, Users press Back button to enter "1.Enter setting" interface, Press OK button to enter main setting interface. Enter "18. DRMS0 Control" by pressing "Down" button, press "OK" button and enter " Input Password " Setting interface . Press "Back" button to set passwords (default: 0001), increase or decrease value though pressing "Up" button or "Down" button, press "OK" button to next value setting. "Error!" Try again" will be displayed for wrong passwords. Press "Back" button and rekey in the correct passwords. If the password is correct, enter the settings "1.enable DRMS0 or press down to enter "2.disable DRMS0", and finally press the OK button to set it successfully.

◆ **Autotest Fast**

Step 1: During the normal operation of our SOLAR inverters, press "back" button (the leftmost button) to enter the main menu interface.

Step 2: Press "Confirm" button (the rightmost button) to enter the "Enter Setting" menu interface.

Step 3: Press "Down" button several times until "Autotest Fast" is shown on the screen.

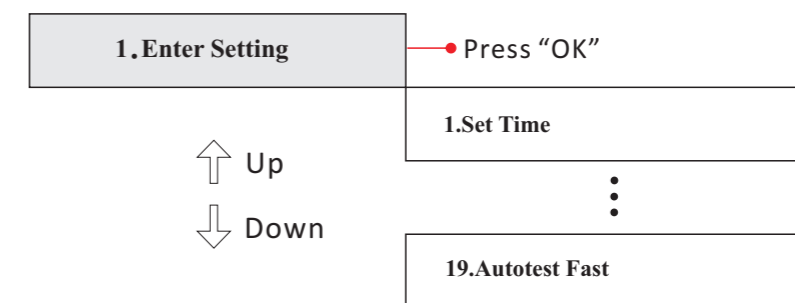

Step 4: Press "Confirm" button to start Auto Test:



Step 5: Then the Auto Test will start automatically, Press "down" to see the test results

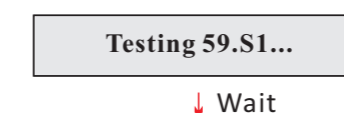

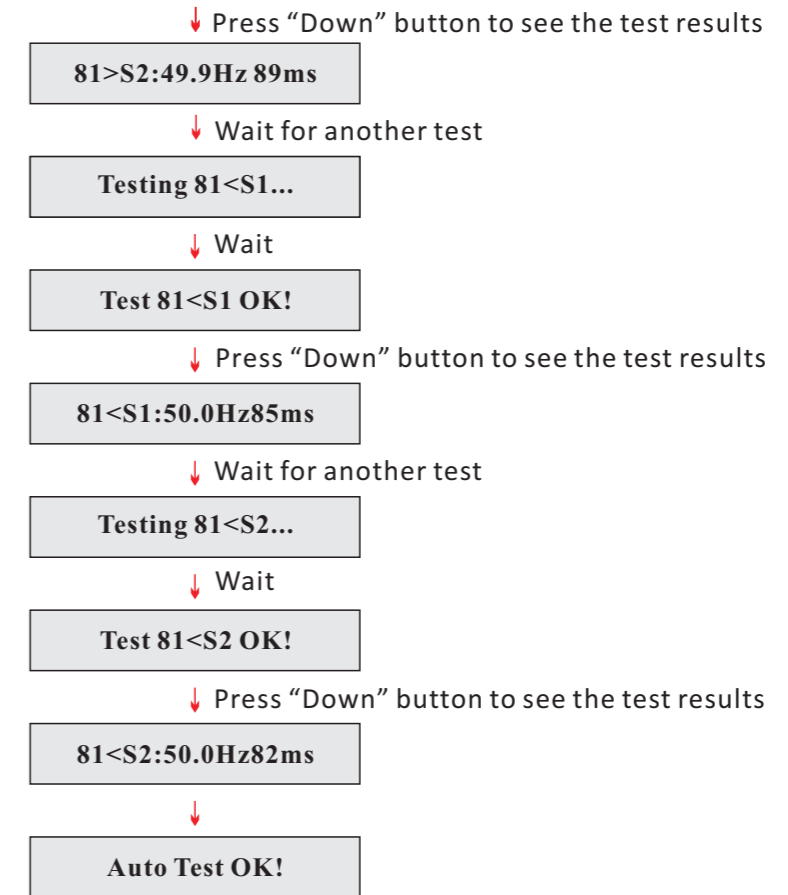
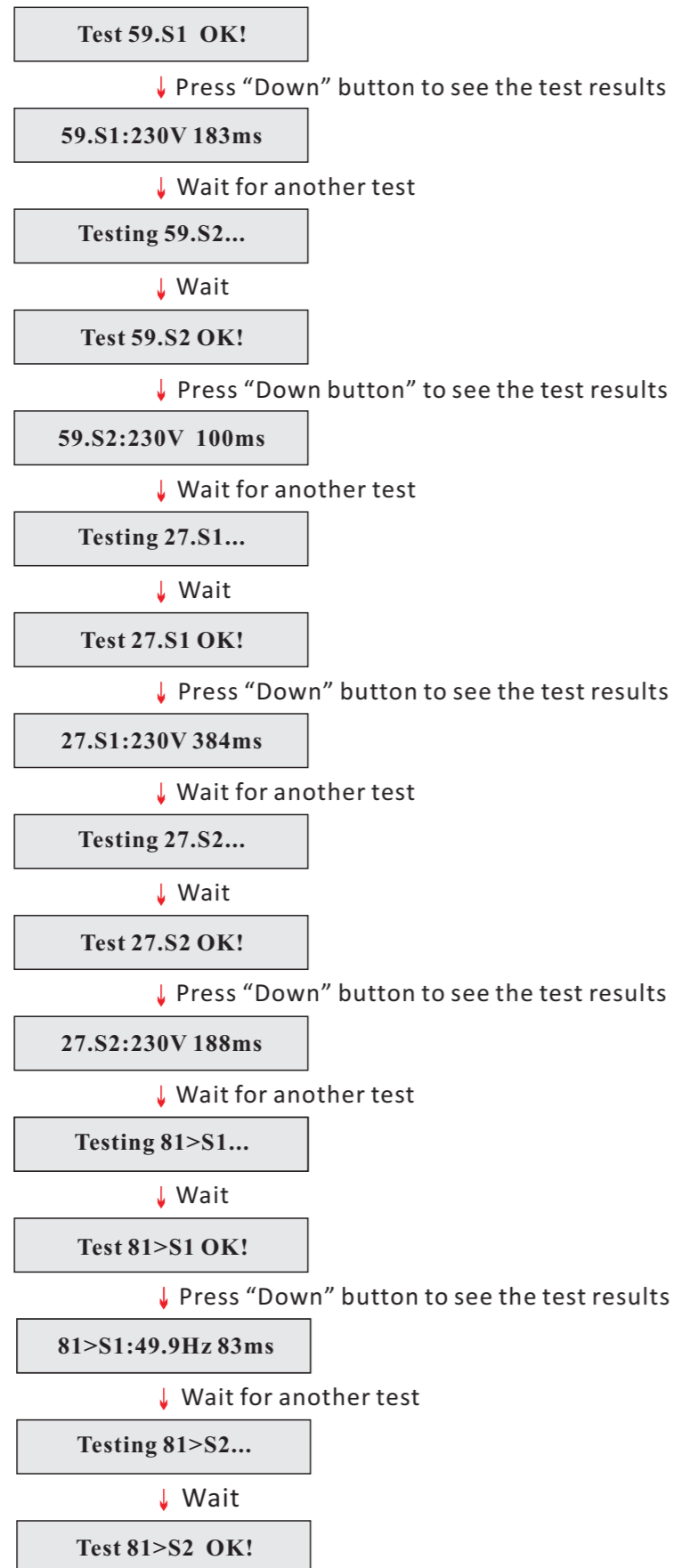

◆ Autotest STD

Step 1: during the normal operation of our SOLAR inverters,press “back”button (the leftmost button) to enter the main menu interface

Step 2:Press “Confirm”button (the rightmost button)to enter the “setting”menu interface.

Step 3:Press “Down”button several times until “Autotest slow”is shown on the screen

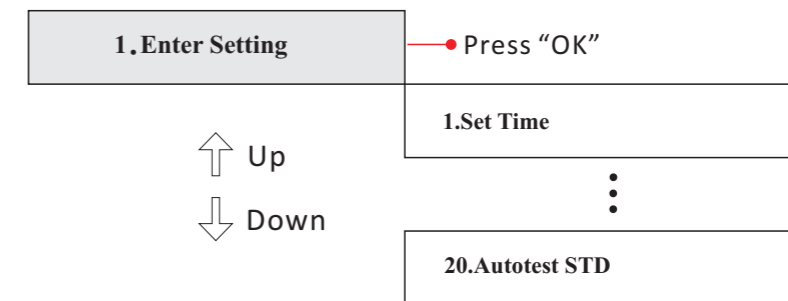

Step 4:Press “Confirm” button to start Auto Test:



Step 5:Then the Auto Test will start automatically, Press “down” to see the test results

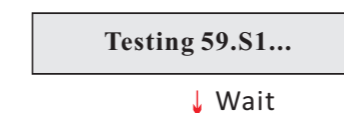

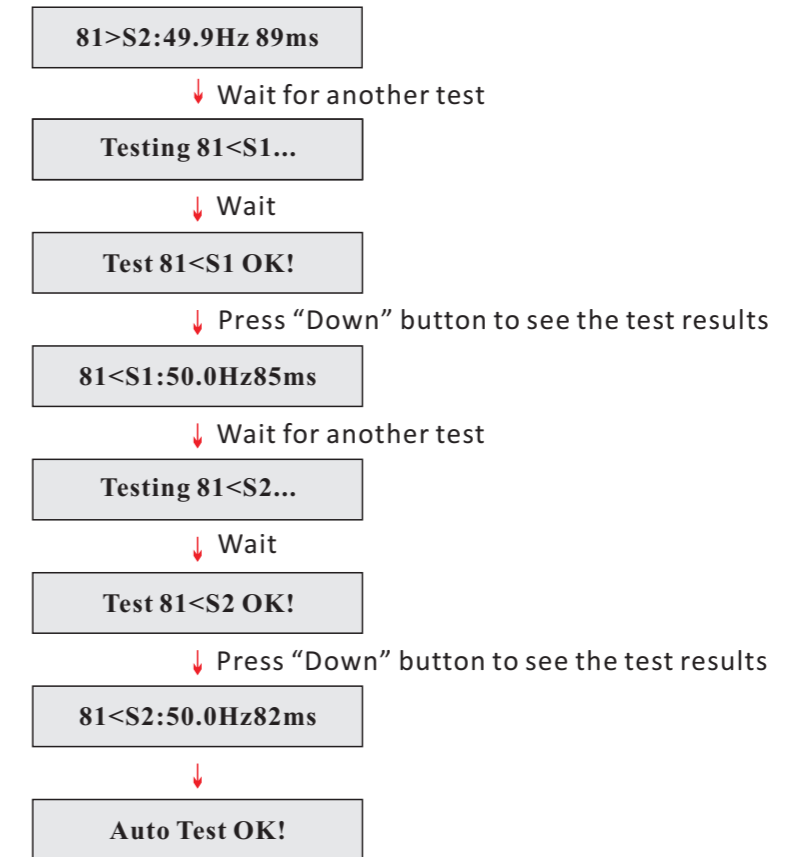
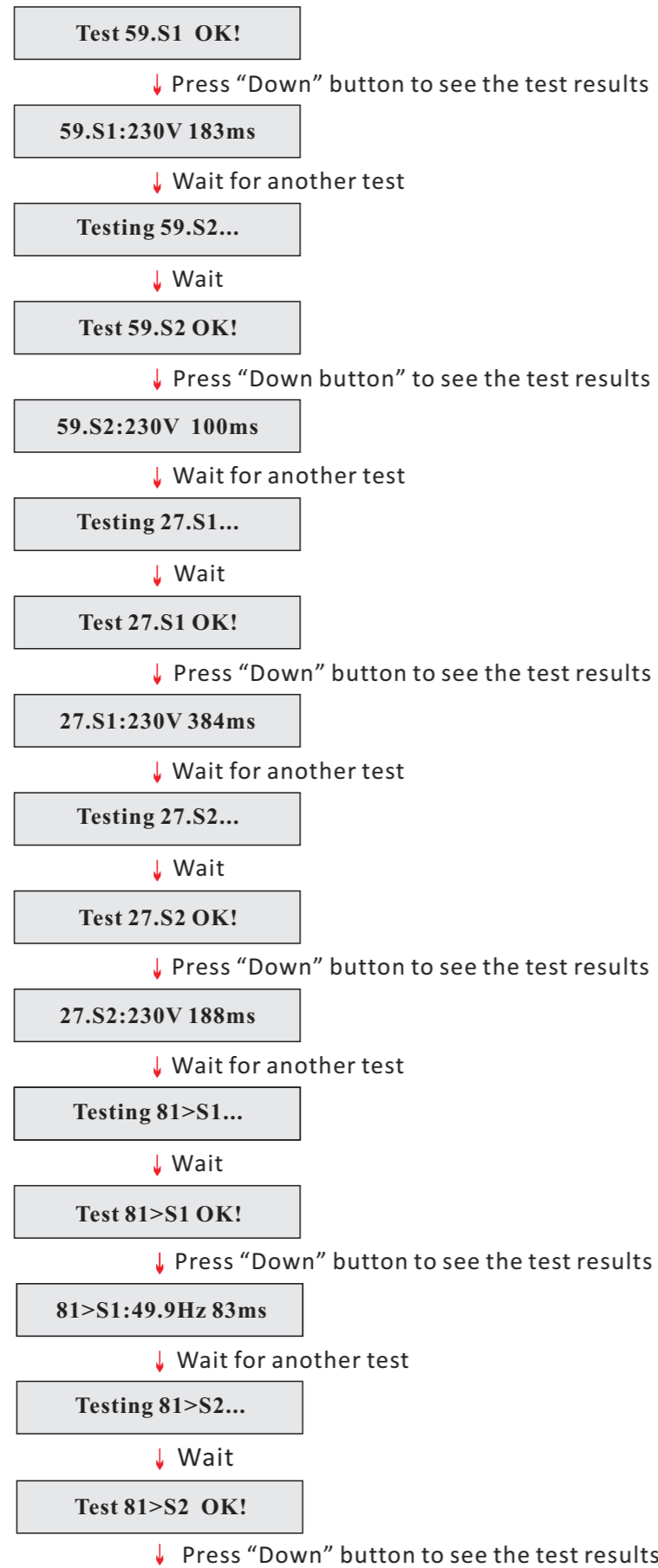

(B) "Event List" Interface as below:

Event List is used to display the real-time event records, including the total number of events and each specific ID No. and happening time. User can enter Event List interface through main interface to check details of real-time event records, Event will be listed by the happening time, and recent events will be listed in the front. Please refer to below picture:

Users press "Back" button and "Down" button in standard interface, then enter into 2.Event List" interface.

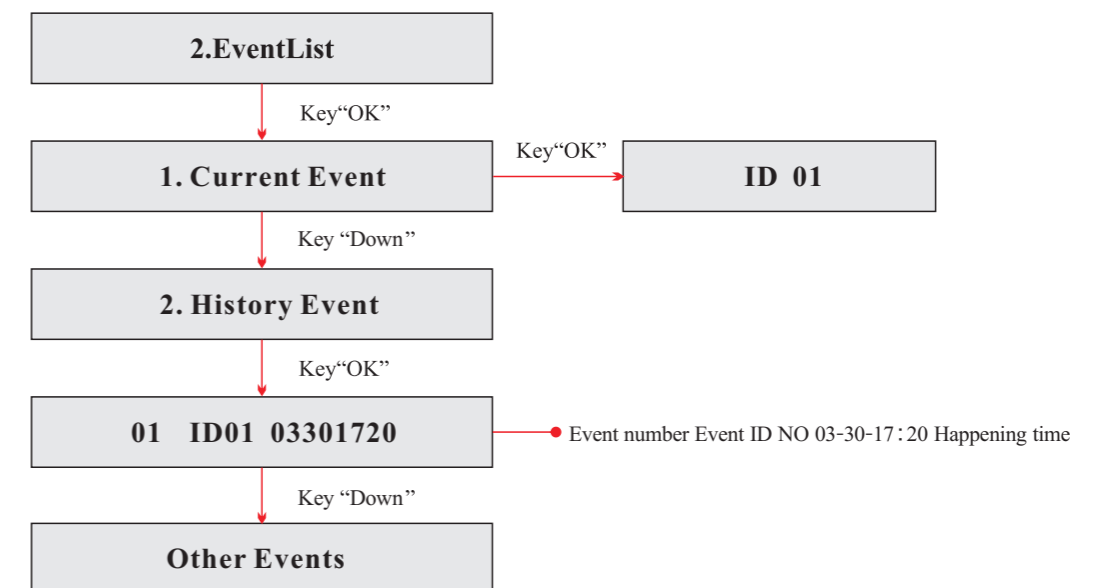

(C) “SystemInfo” Interface as below:

3.SystemInfo	
	1.Inverter Type
	2.Serial Number
	3.SoftVersion
	4.HardVersion
	5.Country
	6.Input Mode
	7.Power factor

◆ Inverter Type

Users press “Back” button and “Up” button or “Down” button enter “3. SystemInfo” interface, Press “OK” button to enter enter into system information checking interface,then press “Up” button or “Down” button enter into “1. Inverter Type”,then press “OK” button , the Inverter Type will be displayed.

◆ Serial Number

Users press “Back” button and “Up” button or “Down” button to enter “3. SystemInfo” interface, Press “OK” button to enter enter into system information checking interface,then press “Up” button or “Down” button enter into “2. Serial Number”,then press “OK” button ,the serial number will be displayed.

◆ SoftVersion

Users press “Back” button and “Up” button or “Down” button to enter “3. SystemInfo” interface, then Press “OK” button to enter enter into system information checking interface,then press “Up” button or “Down” button enter into “3. SoftVersion”,then press “OK” button , the SoftVersion will be displayed.

◆ HardVersion

Users press “Back” button and “Up” button or “Down” button to enter “3. SystemInfo” interface, then Press “OK” button to enter enter into system information checking interface,then press “Up” button or “Down” button enter into “4. HardVersion”,then press “OK” button , the HardVersion will be displayed.

◆ Country

Users press “Back” button and “Up” button or “Down” button to enter “3. SystemInfo” interface, then Press “OK” button to enter enter into system information checking interface,then press “Up” button or “Down” button enter into “5. Country”,then press “OK” button , the Country will be displayed.

◆ Input Mode

Users press “Back” button and “Up” button or “Down” button to enter “3. SystemInfo” interface, then Press “OK” button to enter enter into system information checking interface,then press “Up” button or “Down” button enter into “6. Input Mode”,then press “OK” button , the Input Mode will be displayed.

◆ Power factor

Users press “Back” button and “Up” button or “Down” button to enter “3. SystemInfo” interface, then Press “OK” button to enter enter into system information checking interface,then press “Up” button or “Down” button enter into “7. Power factor ”,then press “OK” button , the Power factor will be displayed.

(D) System Time

Press the “Back” button and “Up” button or “Down” key in the standard user interface to enter into “4.System Time”,then press “OK ” button to display the current system time.

(E) Software Update

Press the “Back” button and “Up” button or “Down” button in the standard user interface to enter into “5. Software Update”,then press “OK” button to enter into the “input password” interface,now press the “OK” button to input the password(initial passwords is 0715),Press the “Up” and “Down” button to change the value,then press “OK” button to confirm the current value of input and enter the next set of value .when set over, if the password is wrong, the LCD will display “Error! Try again”,at this time ,you should re-enter your password.If the password is correct, then begin the update process.

User can check the current software version in SystemInfo>>3. SoftVersion.

online update program steps are as follows:

- Step 1** First, open Sofar 3.3K~12KTL-X waterproof cover.
 - Step 2** After open waterproof cover, Press SD card (the SD card as shown in Figure 4-5), Then the SD card will automatically pop up.
 - Step 3** The SD card reader must be ready by the users, so that SD card so easy to establish the connection with the computer.
 - Step 4** SOFAR SOLAR will send the Software code to the user who needs to update. After user receive the file, please decompressing file and cover the original file in SD card.
 - Step 5** Insert the SD card into the SD card slot, there will be a faint clicking sound typically, indicating that has stuck.
 - Step 6** then enter into the online upgrade to the main menu “5. Software Update” in the LCD display program. The method to enter the menu can refer to operation interface of LCD.
 - Step 7** Input the password, if password is correct, and then begin the update process, the original password is 0715.
 - Step 8** System update main DSP、 slave DSP、 FUSE and ARM in turns. If main DSP update success ,the LCD will display “Update DSP1 OK”, otherwise display “Update DSP1 Fail”; If slave DSP update success ,the LCD will display “Update DSP2 OK”, otherwise display “Update DSP2 Fail”; If FUSE update success ,the LCD will display “Update FUSE OK”, otherwise display “Update FUSE Fail”
 - Step 9** If Fail , please turn off the DC breaker, wait for the LCD screen extinguish, then turn on the DC breaker again,then Continue to update from step 6.
 - Step 10** After the update is completed, turn off the DC breaker, wait for the LCD screen extinguish, then install waterproof cover, and turn on the DC breaker and AC breaker again, the inverter will enters the running state.
- User can check the current software version in SystemInfo>>3. SoftVersion.

Trouble shooting and maintenance

7.1 Trouble shooting

This section contains information and procedures for solving possible problems with the sofars 3.3K~12KTL-X inverter.

☉ **In case of problem with inverter, check the following tips.**

- Check the warning fault messages or Fault codes on the inverter information panel. Record it before doing anything further.
- If inverter does not display any Fault, please check the following lists.
 - Is the inverter located in a clean, dry, adequately ventilated place?
 - Is the DC switch turned ON?
 - Are the cables adequately sized and short enough?
 - Are the input and output connections and wiring in good condition?
 - Are the configuration settings correct for the particular installation?
 - Are the display panel and the communications cable properly connected and undamaged?

Follow the steps below to view recorded problems:

Press “ESC” to enter the main menu in the normal interface. In the interface screen select “Event List”, then press “OK” to enter events.

☉ **EventList information**

Table 7-1 Eventlist

EventList NO.	EventList Name	EventList description	solution
ID01	GridOVP	The power grid voltage is too high	<ul style="list-style-type: none"> • If the alarm occurs occasionally, the possible cause is that the electric grid is abnormal occasionally. SOFAR inverter automatically returns to normal operating status when the electric grid's back to normal. • If the alarm occurs frequently, check whether the grid voltage/frequency is within the acceptable range. If no, contact SOFAR technical support. If yes, check the AC circuit breaker and AC wiring of the SOFAR inverter. • If the grid voltage/frequency is within the acceptable range and AC wiring is correct, while the alarm occurs repeatedly, contact SOFAR technical support to change the grid over-voltage, under-voltage, over-frequency, under-frequency protection points after obtaining approval from the local electrical grid operator.
ID02	GridUVP	The power grid voltage is too low	
ID03	GridOFP	The power grid frequency is too high	
ID04	GridUFP	The power grid frequency is too low	

ID05	PVUVP	The input voltage is too low	Check whether too few PV modules are series connected in a PV string, thus the voltage(Vmp) of the PV string is lower than the minimum operating voltage of SOFAR inverter. If yes, adjust the number of series connected PV modules to increase the voltage of the PV string to fit the input voltage range of SOFAR inverter. SOFAR inverter automatically returns to normal operating status after correct adjustments.
ID06	Vlvrtlow	Low voltage across	Check the AC wiring connection to the electric grid, if it's correct, please contact SOFAR technical support.
ID09	PvOVP	The input voltage is too high	Check whether too many PV modules are series connected in a PV string, thus the voltage(Voc) of the PV string is higher than the maximum input voltage of SOFAR inverter. If yes, adjust the number of series connected PV modules to decrease the voltage of the PV string to fit the input voltage range of SOFAR inverter. SOFAR inverter automatically returns to normal operating status after correct adjustments.
ID10	IpvUnbalance	Input current is not balanced	Check the input mode(parallel mode/ independent mode) setting of SOFAR inverter according to Section 4.5 of this user manual.
ID11	PvConfigSetWrong	Incorrect input mode	
ID12	GFCIFault	GFCI Fault	<ul style="list-style-type: none"> • If the fault occurs occasionally, the possible cause is that the external circuits are abnormal occasionally. SOFAR inverter automatically returns to normal operating status after the fault is rectified. • If the fault occurs frequently and lasts a long time, check whether the insulation resistance between the PV array and earth(ground) is too low, then check the insulation conditions of PV cables.
ID14	HwBoostOCP	The input current is too high, and has happened hardware protection	Check whether the input current is higher than the maximum input current of SOFAR inverters, then check the input wiring, if both are correct, please contact SOFAR technical support.
ID15	HwAcOCP	The grid current is too high, and has happened hardware protection	ID15-ID24 are internal faults of SOFAR inverter, turn OFF the “DC switch”, wait for 5 minutes, then turn ON the “DC switch”. Check whether the fault is rectified. If no, please contact SOFAR technical support.
ID16	AcRmsOCP	The grid current is too high	
ID17	HwADFaultGrid	The grid current sampling error	
ID18	HwADFaultDCI	The DCI sampling error	
ID19	HwADFaultVGrid	The grid voltage sampling error	
ID20	GFCIDeviceFault	The GFCI sampling error	
ID21	MChip_Fault	The master chip fault	
ID22	HwAuxPowerFault	The auxiliary voltage error	
ID23	BusVoltZeroFault	The bus voltage sampling error	
ID24	IacRmsUnbalance	The Output current is not balanced	

ID25	BusUVP	The bus voltage Is too low	If the PV array configuration is correct (no ID5 fault), the possible cause is that the solar irradiance is too low. SOFAR inverter automatically returns to normal operating status after the solar irradiance returns to normal level.	
ID26	BusOVP	The bus voltage Is too high	ID26-ID27 are internal faults of SOFAR inverter, turn OFF the “DC switch”, wait for 5 minutes, then turn ON the “DC switch”. Check whether the fault is rectified. If no, please contact SOFAR technical support.	
ID27	VbusUnbalance	The bus voltage is not balanced		
ID28	DciOCP	The Dci is too high		<ul style="list-style-type: none"> • Check the input mode(parallel mode/ independent mode) setting of SOFAR inverter according to Section 4.5 of this user manual. • If the input mode is correct, turn OFF the “DC switch”, wait for 5 minutes, then turn ON the “DC switch”. Check whether the fault is rectified. If no, please contact SOFAR technical support.
ID29	SwOCPIstant	The grid current is too high	Internal faults of SOFAR inverter, turn OFF the “DC switch”, wait for 5 minutes, then turn ON the “DC switch”. Check whether the fault is rectified. If no, please contact SOFAR technical support.	
ID30	SwBOCPIstant	Ihe input current is too high	Check whether the input current is higher than the maximum input current of SOFAR inverters, then check the input wiring, if both are correct, please contact SOFAR technical support.	
ID49	ConsistentFault_VGrid	The grid voltage sampling value between the master DSP and slave DSP is not consistent	ID49-ID55 are internal faults of SOFAR inverter, turn OFF the “DC switch”, wait for 5 minutes, then turn ON the “DC switch”. Check whether the fault is rectified. If no, please contact SOFAR technical support.	
ID50	ConsistentFault_FGrid	The grid frequency sampling value between the master DSP and slave DSP is not consistent		
ID51	ConsistentFault_DCI	The DCI sampling value between the master DSP and slave DSP is not consistent		
ID52	ConsistentFault_GFCI	The GFCI sampling value between the master DSP and slave DSP is not consistent		
ID53	SpiCommLose	The spi communication between the master DSP and slave DSP is fault		
ID54	SciCommLose	The Sci communication between the control board communication board is fault		
ID55	RelayTestFail	The relays fault		
ID56	PvIsoFault	The insulation resistance is too low		Check the insulation resistance between the PV array and earth(ground), if a short circuit occurs, rectify the fault.
ID58	OverTempFault	The inverter temp is too high		<ul style="list-style-type: none"> • Ensure the installation position and installation method meet the requirements of Section 3.4 of this user manual. • Check whether the ambient temperature of the installation position exceeds the upper limit. If yes, improve ventilation to decrease the temperature. • Check whether the ID90~ID92 fault (fan fault) exist, if yes, please replace the corresponding fan.
ID59	OverTempFault_Env	The environment temp is too high		
ID60	Grounding abnormal	Grounding abnormal	Check whether the ground is solid	

ID65	UnrecoverHwAcOCP	The grid current is too high,and has cause unrecoverable hardware fault	ID65-ID70 are internal faults of SOFAR inverter, turn OFF the “DC switch”, wait for 5 minutes, then turn ON the “DC switch”. Check whether the fault is rectified. If no, please contact SOFAR technical support.
ID66	UnrecoverBusOVP	The bus voltage is too high,and has cause unrecoverable fault	
ID67	UnrecoverIacRmsUnbalance	The grid current is unbalance,and has cause unrecoverable fault	
ID68	UnrecoverIpvUnbalance	The input current is unbalance,and has cause unrecoverable fault	
ID69	UnrecoverVbusUnbalance	The bus voltage Is unbalance,and has cause unrecoverable fault	
ID70	UnrecoverOCPIstant	The grid current is too high,and has cause unrecoverable fault	
ID71	UnrecoverPvConfigSetWrong	Incorrect input mode	
ID74	UnrecoverIPVInstant	The input current is too high,and has happen unrecoverable fault	ID74-ID77 are internal faults of SOFAR inverter, turn OFF the “DC switch”, wait for 5 minutes, then turn ON the “DC switch”. Check whether the fault is rectified. If no, please contact SOFAR technical support.
ID75	UnrecoverWRITEEEPROM	The EEPROM is unrecoverable	
ID76	UnrecoverREADEEPROM	The EEPROM is unrecoverable	
ID77	UnrecoverRelayFail	Relay has happen permanent fault	
ID81	OverTempDerating	the inverter has derated because of the temperature is too high	<ul style="list-style-type: none"> • Ensure the installation position and installation method meet the requirements of Section 3.4 of this user manual. • Check whether the ambient temperature of the installation position exceeds the upper limit. If yes, improve ventilation to decrease the temperature. • Check whether the ID90~ID92 fault (fan fault) exist, if yes, please replace the corresponding fan.
ID82	OverFreqDerating	the inverter has derated because of the grid frequency too hig	SOFAR inverter automatically reduce the output power when the frequency of electrical grid is too high.
ID83	RemoteDerating	The inverter has derated by the Remote control	SOFAR inverter records ID83 in case of remote power derating operation. Check the wiring of remote input and output control signal port on the communication board according to Section 4.4 of this user manual.
ID84	RemoteOff	The inverter has shut down because by the Remote control	SOFAR inverter records ID84 in case of remote shutdown operation. Check the wiring of remote input and output control signal port on the communication board according to Section 4.4 of this user manual.

ID94	Software version is not consistent	The Software between the control board and the communication board is not consistent	Contact SOFAR technical support to upgrade software.
ID95	Communication board EEPROM fault	The Communication board EEPROM is fault	ID95-ID96 are internal faults of SOFAR inverter, turn OFF the "DC switch", wait for 5 minutes, then turn ON the "DC switch". Check whether the fault is rectified. If no, please contact SOFAR technical support.
ID96	RTC clock chip anomaly	RTC clock chip is fault	
ID97	Invalid Country	The Country is InValid	Check the country setting according to Section 4.4 of this user manual.
ID98	SD fault	The SD card is fault	Please replace the SD card.
ID99- ID100	Reserved		Reserved

7.2 Maintenance

Inverters generally do not need any daily or routine maintenance. Cooling fan should not be blocked by dust or any other items.

⦿ Inverter cleaning

Please use hand blower, soft dry cloth or brush to clean inverters. Water, corrosive chemical substances or intense cleaning agent should not be used for cleaning the cooling fan or inverter. Switch off AC and DC power supply to inverter before undertaking any cleaning activity.

8 Decommissioning

8.1 Decommissioning steps

- Switch off the AC grid
- Switch Off the DC switch
- Wait for 5 minutes
- Release the DC connectors
- Release the AC terminals using screw drivers.

8.2 Package

If possible, please pack the inverter in the original packaging.

8.3 Storage

Store the inverter in a dry place where ambient temperature is between -25 and +70 °C.

8.4 Disposal

At the end of its life, dispose inverters and packing materials at locations that can handle and or recycle electric equipment safely.

9 Technical data

9.1 Input parameter (DC)

Parameter	Sofar 3.3KTL-X	Sofar 4.4KTL-X	Sofar 5.5KTL-X	Sofar 6.6KTL-X	Sofar 8.8KTL-X	Sofar 11KTL-X	Sofar 12KTL-X
Max. input voltage	1000V						
Start-up input voltage	180V						
Number of independent MPPT	2						
Number of DC inputs	1 for each MPPT						
Operating input volt range	160V-960V						
Max. input MPPT current	11A/11A						
Input short circuit current for each MPPT	14A						
Input range with Full power operation with 2 MPPT parallel	160V-850V	190V-850V	240V-850V	290V-850V	380V-850V	480V-850V	575V-850V

9.2 Output parameter (AC)

Parameter	Sofar 3.3KTL-X	Sofar 4.4KTL-X	Sofar 5.5KTL-X	Sofar 6.6KTL-X	Sofar 8.8KTL-X	Sofar 11KTL-X	Sofar 12KTL-X
Rated power	3000W	4000W	5000W	6000W	8000W	10000W	12000W
Max. AC power	3300W	4400W	5500W	6600W	8800W	11000W	13200W
Rated apparent power	3300VA	4400VA	5500VA	6600VA	8800VA	11000VA	13200VA
Rated AC voltage	3/N/PE 230V/400V						
Grid voltage range	310-480Vac(adjustable)						
Grid frequency range	44-55Hz/54-66Hz(adjustable, must meet local grid requirements)						
Active power adjustable range	0~100%						
THDI	<3%						
Power factor	1 (adjustable +/-0.8)						
Max. output current	4.8A	6.4A	8.0A	9.6A	12.8A	15.9A	19.1A

9.3 Efficiency, Safety and Protection

Parameter	Sofar 3.3KTL-X	Sofar 4.4KTL-X	Sofar 5.5KTL-X	Sofar 6.6KTL-X	Sofar 8.8KTL-X	Sofar 11KTL-X	Sofar 12KTL-X
Max efficiency	98%				98.3%		
Weighted eff. (EU/CEC)	97.5%				98%		
Self-consumption at night	<1W						
Feed in start power	25W						
MPPT efficiency	>99.5%						
Safety protection	Anti islanding, RCMU, Ground fault monitoring						
Certification	CE,CGC,AS4777,AS3100,VDE4105,C10-C11, G59(more available on request)						
Communication	RS485, Wifi(option), GPRS(option)						
Current(inrush)peak and duration	5.5A/28us						
Maximum output fault current a.c.A	23A				42A		
Maximum output overcurrent protection a.c.A	19.5A				39A		

9.4 General Data

Parameter	Sofar 3.3KTL-X	Sofar 4.4KTL-X	Sofar 5.5KTL-X	Sofar 6.6KTL-X	Sofar 8.8KTL-X	Sofar 11KTL-X	Sofar 12KTL-X
Ambient temperature range	-25°C ~ +60°C						
Allowable relative humidity range	0~100% no condensing						
Topology	Transformerless						
Degree of protection	IP65						
Max. operating altitude	2000m						
Weight	21kg	21kg	21kg	21kg	22kg	22kg	22kg
Cooling	Nature						
Dimension	457X452X200mm						
Warranty	5 years						

10 Quality Assurance

Shenzhen SOFARSOLAR Co., Ltd offers 5 years product warranty for Sofar 3.3K~12KTL-X inverters from date of installation. However the warranty period can't exceed 66 months from the date of delivery of the inverter. During the warranty period, Shenzhen SOFARSOLAR Co., Ltd guarantees normal operation of the inverter.

If during the warranty period, the inverter develops fault, please contact your installation contractor or supplier. In case of faults falling within manufacturers' responsibility, Shenzhen SOFARSOLAR Co., Ltd will provide service and maintenance free of any charge.

Disclaimer:

- Use of Sofar 3.3K~12KTL-X inverters for any other purpose than intended;
- Faulty system design or installation;
- Improper operation;
- Use wrong protection settings on the inverter;
- Carry out unauthorized modification on the inverter.
- Damage because of external factors or the majeure force (such as lightning, over-voltage, bad weather, fire, earthquake, tsunami etc);