



User manual

## PV Grid-Connected Inverter

Product Model: Sofar 30~40KTL Document Version 1.0(2015.08.06)

## Notice

This manual contains important safety instructions that must be followed during installation and maintenance of the equipment.

## Save these instructions!

This manual must be considered as an integral part of the equipment, and must be available at all times to everyone who interacts with the equipment. The manual must always accompany the equipment, even when it is transferred to another user or field.

## Copyright Declaration

The copyright of this manual belongs to Shenzhen SOFARSOLAR Co., Ltd. Any corporation or individual should not plagiarize, partially copy or fully copy it (including software, etc.), and no reproduction or distribution of it in any form or by any means. All rights reserved. SOLARSO FAR reserves the right of final interpretation. This manual is subject to change according to user's or customer's feedback. Please check our website at <http://www.sofarsolar.com> for latest version.

### Shenzhen SOFARSOLAR Co., Ltd.

ADD: 3A, Huake Building, East Tech. Park, Qiaoxiang Road, Nanshan District, Shenzhen, China

[Http://www.sofarsolar.com](http://www.sofarsolar.com)

P. C. : 518000

E-mail: [service@sofarsolar.com](mailto:service@sofarsolar.com)

# Preface

## Outline

Please read the product manual carefully before installation, operation or maintenance. This manual contains important safety instructions and installation instructions that must be followed during installation and maintenance of the equipment.

### • Scope

This product manual describes the assembly, installation, commissioning, and maintenance of the following inverters.

Sofar 30000-Sx Sofar 33000-Sx Sofar 40000-Sx(x=0-2)





Keep this manual where it will be accessible at all times.

### • Target Group

This manual is for qualified person (support person, service person are qualified mentioned in this manual).

### • Symbols Used

This manual provides safety operation information and uses the symbol in order to ensure personal and property security and use the inverter efficiently when operating the inverter. You must understand these emphasize information to avoid the personal injury and property loss. Please read the following symbols which used in this manual carefully.

 <b>Danger</b>	<b>Danger indicates a hazardous situation which, if not avoided, will result in death or serious injury.</b>
 <b>Warning</b>	<b>Warning indicates a hazardous situation which, if not avoided, could result in death or serious injury.</b>
 <b>Caution</b>	<b>Caution indicates a hazardous situation, if not avoided, could result in minor or moderate injury.</b>
 <b>Attention</b>	<b>Attention indicates there are potential risks. If fail to prevent, may lead to equipment cannot run normally or property damage.</b>
 <b>Note</b>	<b>Note provides tips that are valuable for the optimal operation of the product.</b>

# Table of contents

<b>Preface</b> .....	<b>II</b>
<b>1 Basic safety information</b> .....	<b>1</b>
1.1 Safety instructions .....	1
1.2 Symbols and signs .....	3
<b>2 Product characteristics</b> .....	<b>5</b>
2.1 Product identification .....	5
2.2 Function description .....	11
2.3 Protection modules .....	13
2.4 Efficiency and derating curve .....	14
<b>3 Installation</b> .....	<b>15</b>
3.1 Installation Process .....	16
3.2 Checking Before Installation .....	16
3.3 Tools .....	18
3.4 Determining the Installation Position .....	20
3.5 Moving the sofar 30~40KTL .....	21
3.6 Installing the sofar 30~40KTL .....	22
<b>4 Electrical Connections</b> .....	<b>24</b>
4.1 Electrical connection .....	25
4.2 Connecting PGND Cables .....	25
4.3 Connecting AC Output Power Cables .....	27
4.4 Connecting Communications Cables .....	29
4.5 Connecting DC Input Power Cables .....	36
4.6 Safety check .....	41
<b>5 Commissioning of inverter</b> .....	<b>42</b>
5.1 Safety inspection before commissioning .....	42
5.2 Start inverter .....	42

<b>6 Operation interface</b> .....	<b>43</b>
6.1 Operation and Display Panel .....	43
6.2 Standard Interface .....	44
6.3 Main Interface .....	46
<b>7 Trouble shooting and maintenance</b> .....	<b>55</b>
7.1 Trouble shooting .....	55
7.2 Maintenance .....	59
<b>8 Decommissioning</b> .....	<b>60</b>
8.1 Decommissioning steps .....	60
8.2 Package .....	60
8.3 Storage .....	60
8.4 Disposal .....	60
<b>9 Technical data</b> .....	<b>61</b>
9.1 Input parameter (DC) .....	61
9.2 Output parameter (AC) .....	62
9.3 Efficiency, Safety and Protection .....	62
9.4 General Data .....	63
<b>10 Quality Assurance</b> .....	<b>64</b>

# Basic safety information

 <b>Note</b>	<p>If you have any question or problem when you read the following information, please contact Shenzhen SOFARSOLAR Co., Ltd.</p>
--	--

## Outlines of this chapter

### safety instruction

It mainly introduce the safety instruction when install and operate the equipment.

### Symbols and signs

It mainly introduce the safety symbols on the inverter.

## 1.1 Safety instructions

Read and understand the instruction of this manual ,and be familiar with relevant safety symbols in the paragraph, then start to install and debug the equipment.According to the national and state requirements, before connect the grid ,you must get power department permission, and perform the operation only by qualified electrical engineer.Before installing and maintaining the equipment, you should cut off the high voltage application of PV array. You can also open the switch of Solar Array Combiner to cut off the high voltage. Otherwise, serious injury may be caused.

### Qualified persons

The customer must make sure the operator has the necessary skill and training to do his/her job. Staff in charge of using and maintaining the equipment must be skilled, aware and mature for the described tasks and must have the reliability to correctly interpret what is described in the manual. For safety reason only a qualified electrician, who has received training and / or has demonstrated skills and knowledge in construction and in operation of this unit, can install this inverter. Shenzhen SOFARSOLAR Co., Ltd does not take any responsibility for the property destruction and personal injury because of any incorrect use.

### Assembly situation requirements

Please install and start inverter according to the following sections. Put the inverter in appropriate bearing capacity objects(such as wall and components and so on), to ensure that inverter vertical placed. Choose suitable place for installing electrical equipment. And assure enough fire exit space, convenience for maintenance. Maintain proper ventilation, and ensure that have the enough air cooling cycle.

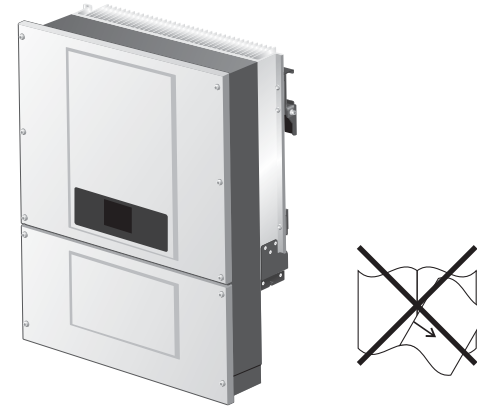





## Transport requirements



If you find packing problems that may cause the damage of the inverter, or find any visible damage, please immediately notice the responsible transportation company. You can ask solar equipment installation contractor or Shenzhen SOFARSOLAR Co.Ltd for help if necessary. Transport of the equipment, especially by road, must be carried out with by suitable ways and means for protecting the components (in particular, the electronic components) from violent shocks, humidity, vibration, etc.

## Electric connection



Please comply with all the current electrical regulations about accident prevention in dealing with the current inverter.

 <b>Danger</b>	<ul style="list-style-type: none"> <li>• Before the electrical connection, make sure to use opaque material to cover the PV modules or to disconnect PV array DC switch. Exposure to the sun, PV array will produce a dangerous voltage!</li> <li>• When the photovoltaic array is exposed to light, it supplies a DC voltage to the PCE.</li> </ul>
 <b>Warning</b>	<p><b>All installation accomplished only by professional electrical engineer!</b></p> <ul style="list-style-type: none"> <li>• must be trained;</li> <li>• Completely read the manual operation and understand relevant matters.</li> <li>• Electrical installation and maintenance shall be conducted by qualified electrician and shall comply with national wiring rules.</li> </ul>
 <b>Attention</b>	<p><b>Only get permission by the local power department and complete all electrical connection by professional electrical engineer then connect inverter into grid!</b></p>
 <b>Note</b>	<p><b>The equipment is composed of two cases. It's forbidden to remove the tamper evident label, and open the upper case. Otherwise Sofarsolar will not provide service and maintenance.!</b></p>

## Operation

 <b>Danger</b>	<p><b>Touching the power grid or the terminal of equipment may lead to die of electric shock or fire!</b></p> <ul style="list-style-type: none"> <li>• Don't touch the terminal or conductor which connect to the power circuit;</li> <li>• Pay attention to anything about grid connection and security document.</li> </ul>
 <b>Attention</b>	<p><b>Some internal components will be very hot when inverter is working. Please wear protective gloves!</b></p>

## Maintenance and repair

 <b>Danger</b>	<ul style="list-style-type: none"> <li>• Disconnected with the PV components array and electricity grid before any repair work;</li> <li>• After turn off AC breaker and DC switch for 5 minutes later, the maintenance or repair of the inverter can be carried out!</li> </ul>
 <b>Attention</b>	<ul style="list-style-type: none"> <li>• Inverter should work again after removing any faults. If you need any repair work, please contact with the local authorized service center;</li> <li>• Can't open the internal components of inverter without authorized. Shenzhen SOFARSOLAR Co., Ltd. does not take any responsibility for the losses from that.</li> </ul>

## EMC / noise level of inverter

Electromagnetic compatibility (EMC) refers to that one electrical equipment functions in a given electromagnetic environment without any trouble or error, and impose no unacceptable effect upon the environment. Therefore, EMC represents the quality characters of electrical equipment.



- The inherent noise-immune character: immunity to internal electrical noise.
- External noise immunity: immunity to electromagnetic noise in external system.
- Noise emission level: influence of electromagnetic emission upon environment.

 <b>Danger</b>	<p><b>Electromagnetic radiation from inverter may be harmful to health!</b></p> <ul style="list-style-type: none"> <li>• Please do not continue to stay away from the inverter in less than 20 cm when inverter is working.</li> </ul>
--	--

## 1.2 Symbols and signs









### Safety symbols

 <b>Danger</b>	<p><b>Electromagnetic radiation from inverter may be harmful to health!</b></p> <ul style="list-style-type: none"> <li>• Please do not continue to stay away from the inverter in less than 20 cm when inverter is working.</li> </ul>
--	--

 <b>Caution</b>	<p><b>Caution of burn injuries due to hot enclosure parts!</b></p> <ul style="list-style-type: none"> <li>• During working only can touch the display and key parts of inverter.</li> </ul>
 <b>Attention</b>	<p><b>PV array should be connected to the ground in accordance with requirements of local power department!</b></p> <ul style="list-style-type: none"> <li>• To protect system and the personnel security, we suggest that PV array of border and inverter should be reliable grounding .</li> </ul>
 <b>Warning</b>	<p><b>Ensure input DC voltage &lt; Max.DC voltage .Over voltage may cause permanent damage to inverter or other losses, which will not be included in warranty!</b></p>

## Signs on the inverter

There are some symbols which are related to security on the inverter. Please read and understand the content of the symbols, and then start the installation.

	<p>There is residual voltage in the inverter! Before open the equipment, operator should wait for five minutes to ensure the capacitance discharge completely.</p>
	<p>Be careful of high voltage.</p>
	<p>Be careful of high temperature.</p>
	<p>Conformity with European.</p>
	<p>Point of connection for grounding.</p>
	<p>This indicates the allowed temperature range.</p>
	<p>This indicates the degree of protection of the equipment according to IEC standard 70-1 (EN 60529 June 1997).</p>
	<p>Positive pole and negative pole of the input voltage (DC).</p>

# 2 Product characteristics

## Outlines of this chapter

### Product identification

It introduces the field of use, and how to identify different types of Sofar 30~40KTL.

### Function description

It introduces how the inverter works and the function modules inside.

### Protection modules

It introduce the protection modules in the inverter.

## 2.1 Product identification

### Field of use

This equipment is a multi-string inverter designed to: transform a direct electric current (DC) coming from a photovoltaic generator (PV) into an alternating electric current (AC) Suitable for being fed into the national grid.

Figure2-1 PV Grid-tied System

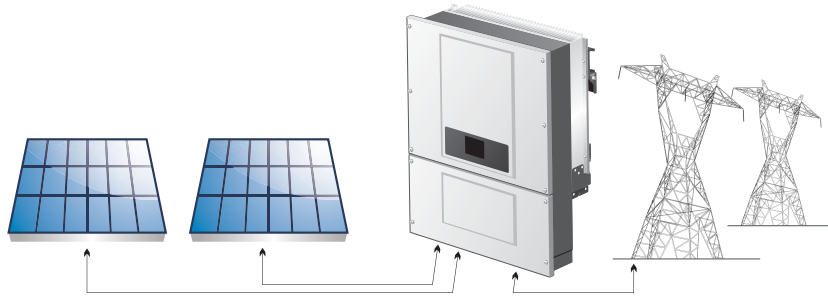

The inverter can be used only with photovoltaic modules that do not require one of the poles to be grounded.

The operating current during normal operation must not exceed the limits specified in the technical specifications.

Only the photovoltaic generator can be connected to the input of the inverter (do not connect batteries or other sources of power supply)

### Intended grid types:

Sofar 30~40KTL inverters are compatible with TN-S、TN-C、TN-C-S、TT、IT grid configurations。 For the TT type of electricity grid, the voltage between neutral and earth should be less than 30V.

Figure2-2 Overview of the grid configurations

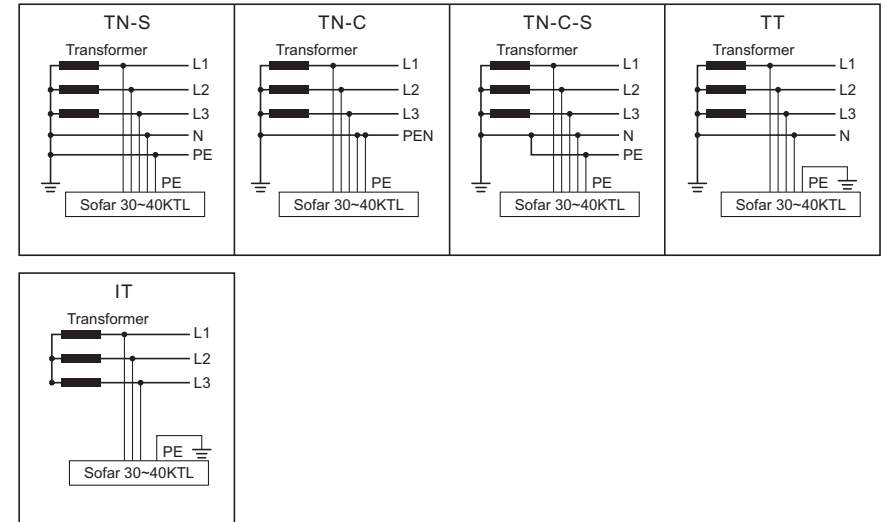

### Components of the inverter:

Figure2-3 Two parts of the inverter

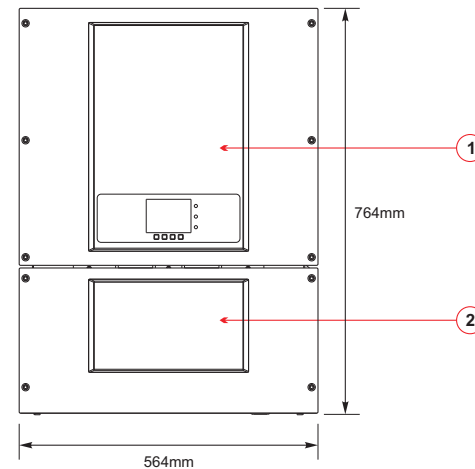

1 power converter part 2 wiring box

- The specific models of multi-string inverter that this manual is about are divided into three groups according to the maximum output power (30 kW, 33kW and 40 kW).
- For inverters of equal output power, the variant between the various models is the layout of the wiring box 2. The wiring box 2 has three configuration (sx = 0, 1, 2).

Figure2-4 Components of bottom view(1)

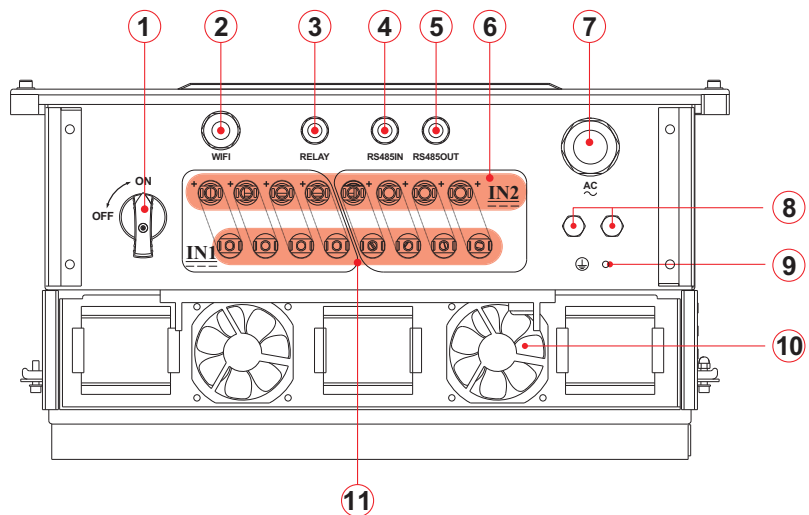

1. DC switch
2. WIFI cable gland
3. Dry contact
4. RS485 input cable gland
5. RS485 output cable gland
6. DC positive poles connectors
7. AC cable gland
8. Anti-condensation valve
9. Earth terminal
10. Fan
11. DC Negative poles connectors

## S0

Figure2-5 Wiring Box components (1)

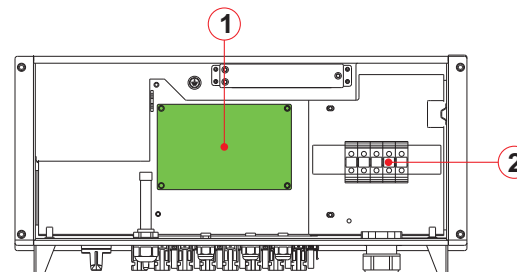

1. Communication board
2. Output AC connector

## S1

Figure2-6 Wiring Box components (2)

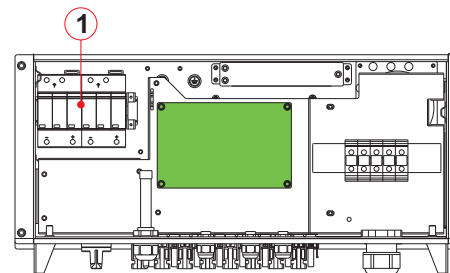

1. DC surge protector(II)

## S2

Figure2-7 Wiring Box components (3)

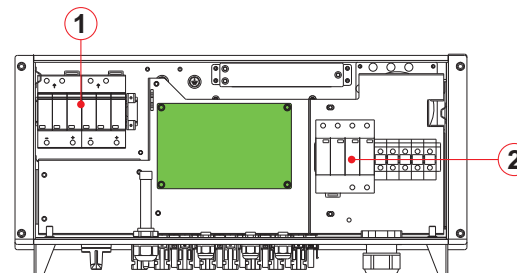

1. DC surge protector(II)
2. AC surge protector(II)



- The choice of model of inverter must be made by a qualified technician who knows about the installation conditions, the devices that will be installed outside the inverter and possible integration with an existing system.

**Inverter type identification:**

**SOFAR - 30000 TL Sx**

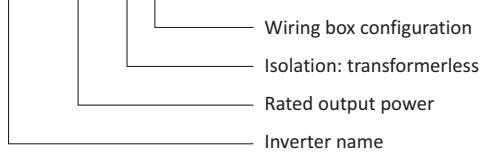

- Overall dimensions: L×W×H=764.0mm×564.0mm×290.5mm.

Figure2-8 Front view and left view dimensions

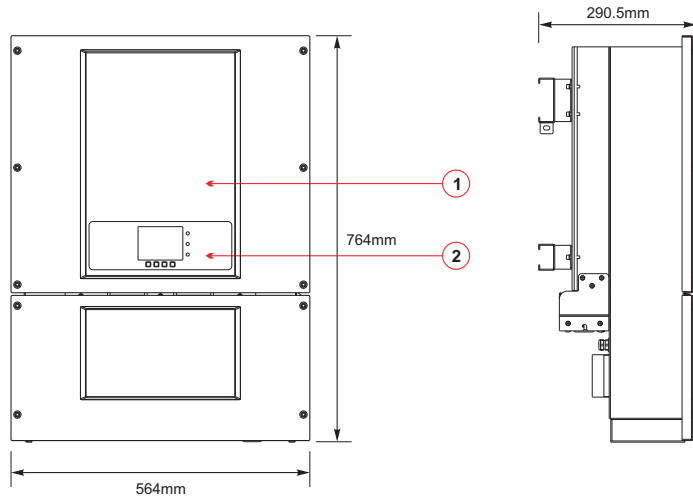

1. Cabinet 2. Human Interface board

Figure2-9 Back view and Bracket dimensions

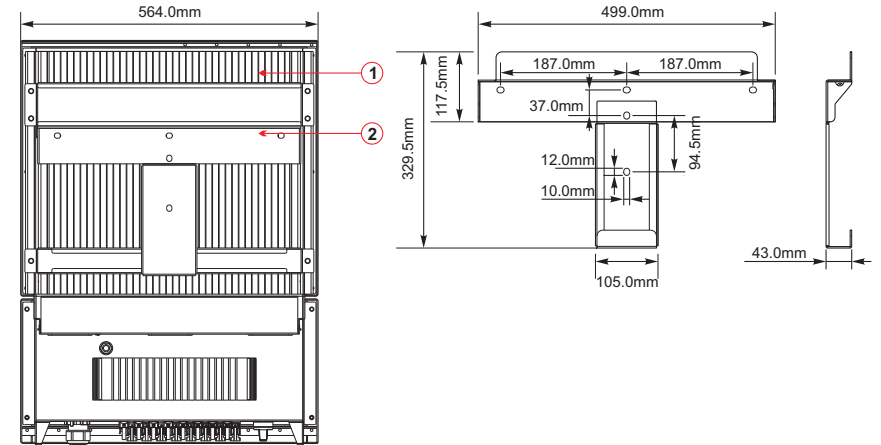

1. Heat sink 2. Bracket

**Identification labels of the equipment :**



The labels must NOT be hidden with objects and extraneous parts (rags, boxes, equipment, etc.); they must be cleaned regularly and kept visible at all times.

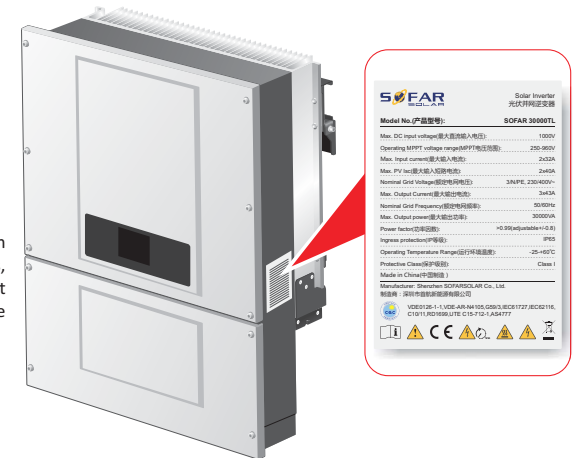

SOFAR Solar Inverter 光伏并网逆变器	
Model No. 产品型号:	SOFAR 30000TL
Max. DC Input Voltage 最大直流输入电压:	1000V
Operating MPPT Voltage Range 光伏最佳电压范围:	250-800V
Max. Input Current 最大输入电流:	20.0A
Max. PV Insulation Resistance 最大绝缘电阻:	2.0MΩ
Nominal Grid Voltage 额定电网电压:	380VAC
Max. Output Current 最大输出电流:	30.0A
Nominal Grid Frequency 额定电网频率:	50/60Hz
Max. Output Power 最大输出功率:	30000W
Power Factor 功率因数:	>0.99@额定功率
Ingress protection 防护等级:	IP65
Operating Temperature Range 运行环境温度:	-25~+65°C
Protection Class 防护等级:	Class I
Manufacturer 制造商:	Shenzhen SOFARSOLAR Co., Ltd.
Model No. 产品型号:	V50030K-1-1-0SE-AR-NA-105-0003-000177-000116
Model No. 产品型号:	C10111-001000-LITE C10-110-0-AS4777



## 2.2 Function description

### Operating Principle

DC power generated by PV array is filtered through string detection board and input board before entering into Power board. Input board also offer functions such as insulation impedance detection and input DC voltage / current detection. DC power is converted to AC power by Power board. AC power is filtered through Output board then AC power is fed into the grid. Output board also offer functions such as grid voltage / output current detection, GFCI and output isolation relay. Control board provides the auxiliary power, controls the operation state of inverter and shows the operation status by Display board. Display board displays fault code when inverter is in abnormal operation conditions. At the same time, Control board can trigger the relay so as to protect the internal components.

### Operating Principle

- The string detection board detects the input voltage / current, analyses the operating status of each PV string and alerts the user that a maintenance required if a problem occurs in the PV string;
- The DC switch disconnects internal circuits from the DC input to facilitate maintenance;
- DC SPD (category III, category II is added to S1 & S2) provides the discharge loop for the overvoltage power on the DC side to protect the sof ar 30~40KTL internal circuits from DC overvoltage;
- The input and output electromagnetic interference (EMI) filters filter out the EMI inside the sof ar 30~40KTL to ensure that the sof ar 30~40KTL meets electromagnetic compatibility requirements;
- The Input Board detects the insulation impedance of the PV array and ensures the maximum output power of the PV system by measuring the voltages & currents of PV array and tracking the maximum power point (MPPT);
- The DC-AC conversion circuit converts DC power into AC power and then the AC power is fed into the electric grid. The AC output power quality meets the requirements of the electric grid;
- The output isolation relay isolates the inverter from the electric grid when the grid or the inverter is faulty.
- The LC filter filters out the high-frequency components from the AC output of sof ar 30~40KTL to ensure that the AC output meets electric grid requirements;
- AC SPD (category III, category II is added to S2) provides the discharge loop for the overvoltage power on the AC side to protect the sof ar 30~40KTL internal circuits from AC overvoltage;
- The Communication Board enables the inverter to communicate via RS485, WIFI(optional), user can access all the operating data via the web browser(PC) and APP(ios & android).

Figure2-10 Electrical block diagram

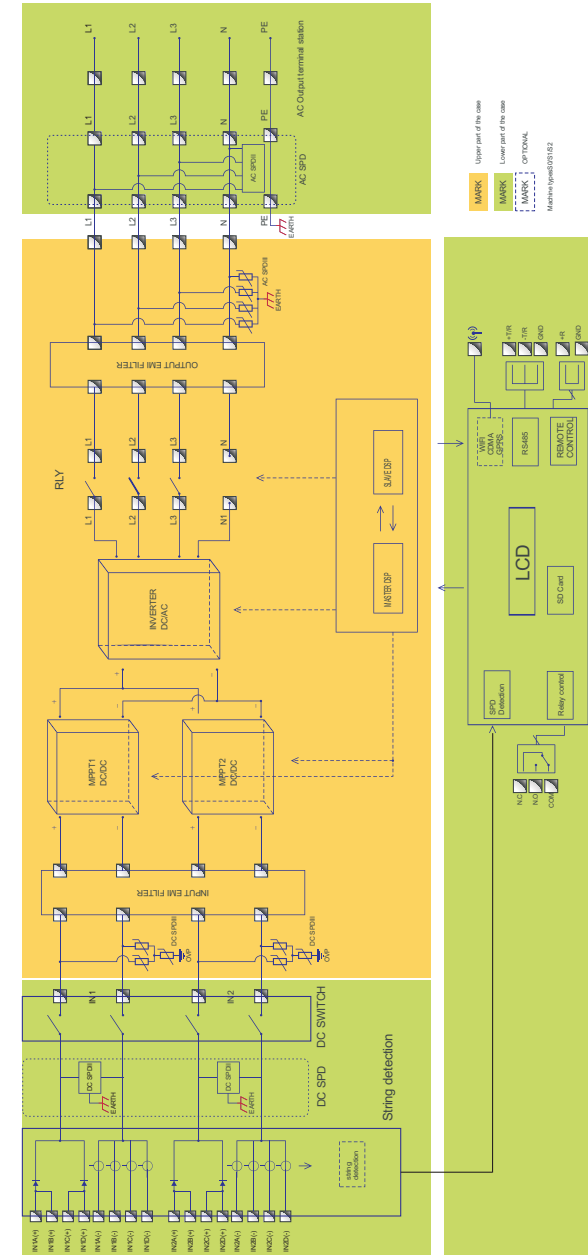

## Function module

### A. Configurable relay

The inverter has a configurable switching relay that can be used in various operating conditions set in the dedicated menu. A typical application example is the closing of the contact when an alarm occurs.

### B. Energy management unit

#### B.1 Remote switching on/off

This control can be used to switch the inverter on/off through an external (remote) control.

#### B.2 Feeding reactive power into the grid

The inverter is able to produce reactive power and can therefore feed it into the grid through the setting of the phase shift factor. Feed-in management can be controlled directly by the grid company through a dedicated RS485 serial interface.

#### B.3 Limiting the active power fed into the grid

The inverter, if enabled can limit the amount of active power fed into the grid by the inverter to the desired value (expressed as a percentage).

#### B.4 Self power reduction when grid over frequency

When the grid frequency is over limited value, inverter will reduce output power which do good to the grid stability.

#### B.5 Power reduction due to environmental conditions, input output voltage

The power reduction value and the inverter temperature at which it occurs depend on the ambient temperature and on many operating para-meters. Example: input voltage, grid voltage and power available from the photovoltaic field. The inverter can therefore reduce the power during certain periods of the day and according to the value of these parameters.

### C. Data transmission

The inverter may be monitored remotely through an advanced communications system based on an RS485 serial interface, or remotely via the WIFI.

### D. Software update

SD card is used for updating the firmware.

### E. Monitoring string inputs

The inverter can monitor and display the voltage and current of each individual string input. It also checks the status of the strings and generates a warning in the event of a fault.

### F. Monitoring surge arresters (S1,S2 versions only)

The inverter monitors the status of the surge arresters (both AC and DC) and generates a warning in the event of a fault (visible on the display).

## 2.3 Protection modules

### A. Anti-islanding

In the event of a local grid outage by the electricity company, or when the equipment is switched off for maintenance operations, the inverter must be physically disconnected safely, to ensure protection of people working on the grid, all in accordance with the relevant national standards and laws. To prevent possible islanding, the inverter is equipped with an automatic protective disconnection system called "Anti-Islanding".

### B. RCMU

Sofar inverters are equipped with a redundancy on the reading of the ground leakage current sensitive to all components of both direct and alternating current. Measurement of the ground leakage current is carried out at the same time and independently by 2 different processors: it is sufficient for one of the two to detect an anomaly to trip the protection, with consequent separation from the grid and stopping of the conversion process.

### C. Grid monitoring

Continuous monitoring of the grid voltage to ensure the voltage and frequency values stay within operating limits.

### D. Inverter internal device protection

The inverter has all kinds of internal protection to protect the device inside when grid or input DC side have abnormal situation.

### E. Ground fault protection

This inverter must be used with panels connected with "floating" connections, that is, with positive and negative terminals without ground connections. An advanced ground fault protection circuit continuously monitors the ground connection and disconnects the inverter when a ground fault is detected. The ground fault condition is indicated by a red LED on the front panel.

## 2.4 Efficiency and derating curve

### Efficiency curve

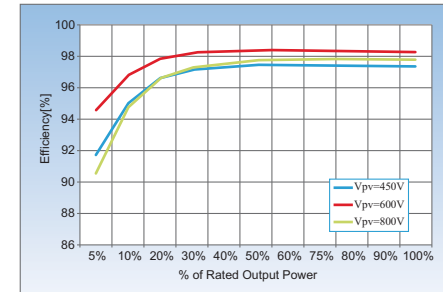

### Input voltage derating curve

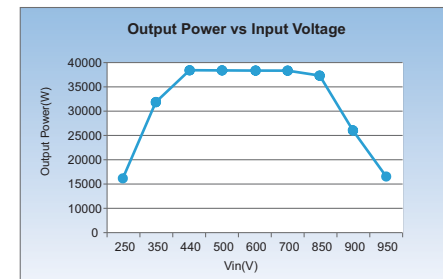

### Output voltage derating curve

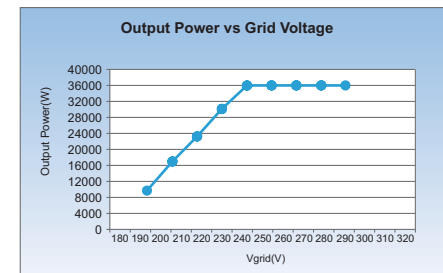



# 3 Installation

## Outlines of this chapter

This topic describes how to install the Sofar 30~40KTL.

### Installation notes

 <b>Danger</b>	<ul style="list-style-type: none"> <li>Do not install the Sofar 30~40KTL on flammable building materials.</li> <li>Do not store the Sofar 30~40KTL in areas with flammable or explosive materials.</li> </ul>
 <b>Caution</b>	Do not install the Sofar 30~40KTL in places prone to body contact because the Sofar 30~40KTL shelf and heat sinks become hot during the Sofar 30~40KTL operation.
 <b>Attention</b>	<ul style="list-style-type: none"> <li>Take the Sofar 30~40KTL weight into consideration when transporting and moving the Sofar 30~40KTL.</li> <li>Install the Sofar 30~40KTL in an appropriate position and surface.</li> <li>Assign at least two persons to install the Sofar 30~40KTL.</li> </ul>

### 3.1 Installation Process

This topic describes the process for installing the Sofar 30~40KTL.

#### 3.2 Checking Before Installation

Before unpacking, check that the packing materials are intact. After unpacking, check that the deliverables are complete and intact.

#### 3.3 Tools

Prepare tools required for installation and electrical connections.

#### 3.4 Determining the Installation Position

Determine an appropriate position for installing the Sofar 30~40KTL.

#### 3.5 Moving the Sofar 30~40KTL

This topic describes how to move the Sofar 30~40KTL to the installation position horizontally.

#### 3.6 Installing the Sofar 30~40KTL

Before installing the Sofar 30~40KTL, secure the shipped rear panel to the wall. Then secure the Sofar 30~40KTL to the rear panel by using hexagon screws.

## 3.1 Installation Process

Figure3-1 Installation flowchart

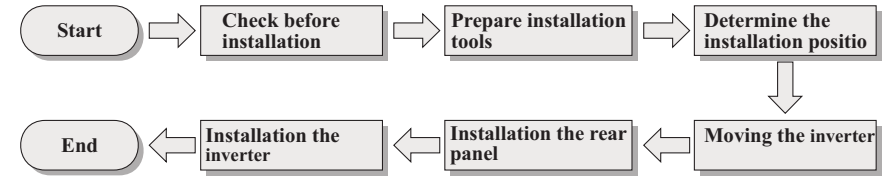

## 3.2 Checking Before Installation











### Checking Outer Packing Materials

Packing materials and components may be damaged during transportation. Therefore, check the outer packing materials before installing the inverter. Checking the surface of packing materials for damage, such as holes and cracks. If any damage is found, do not unpack the inverter and contact the dealer as soon as possible. You are advised to remove the packing materials within 24 hours before installing the inverter.

### Checking Deliverables

After unpacking the inverter, check whether deliverables are intact and complete. If any damage is found or any component is missed, contact the dealer.

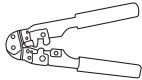





Table3-1 shows the components and mechanical parts that should be delivered









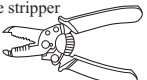

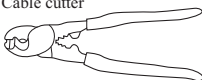
No.	Pictures	Quantity	Description
1		1PCS	Sofar 30~40KTL
2		1PCS	Rear panel
3		8PCS	DC+ input terminal
4		8PCS	DC- input terminal
5		8PCS	Metal terminals secured to DC+ input power cables
6		8PCS	Metal terminals secured to DC- input power cables
7		1PCS	M4 Hexagon screws
8		5PCS	M8*80 Expansion bolts used to secure the rear panel to the wall
9		1PCS	Manual
10		1PCS	The warranty card
11		1PCS	Certificate

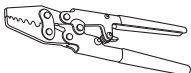
### 3.3 Tools

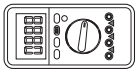
Prepare tools required for installation and electrical connections.

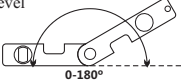
Table3-1 Shows the components and mechanical parts that should be delivered

Tool	Model	Function
Hammer drill 	With a drill bit of $\Phi 8.0$	Used to drill holes on the wall
RJ45 crimping tool 	N/A	Used to prepare RJ45 connectors for Communications cables
Adjustable wrench 	With an open end of larger than or greater than 32 mm	Used to tighten expansion bolts
Flat-head screwdriver 	M4	<ul style="list-style-type: none"> <li>Used to tighten or loosen screws when installing AC power cables.</li> <li>Used to remove AC connectors from the sofar 30~40KTL.</li> </ul> Note: The torque screwdriver and flat-head screwdriver are alternative.
Socket wrench 	M5	Used to tighten ground bolts
Rubber mallet 	N/A	Used to hammer expansion bolts into holes
Removal tool 	N/A	Used to remove DC connectors from the sofar 30~40KTL
Diagonal pliers 	N/A	Used to cut and tighten cable ties
Wire stripper 	N/A	Used to peel cable jackets

Tool	Model	Function
	RJ45	2PCS
Cable cutter 	N/A	Used to cut power cables
Hexagon socket 	M4,M6	M6 use to uninstall and install the front top cover and down cover. M4 use to install the rear panel on the sofar 30~40KTL.
Crimping tools 	N/A	Used to crimp power cables
Vacuum cleaner 	N/A	Used to clean up dusts after drilling holes
Multimeter 	N/A	Used to check grounding
Marker 	N/A	Used to mark signs
Measuring tape 	N/A	Used to measure distances
Level 	N/A	Used to ensure that the rear panel is properly installed 0-180°
ESD gloves 	N/A	Operators wear ESD gloves when installing equipment.
Safety goggles 	N/A	Punch operator wearing
Anti-dust respirator 	N/A	Punch operator wearing

### 3.4 Determining the Installation Position

Determine an appropriate position for installing the Sofar 30~40KTL.

Comply with the following requirements when determining the installation position:

Figure 3-2 Installation position requirements

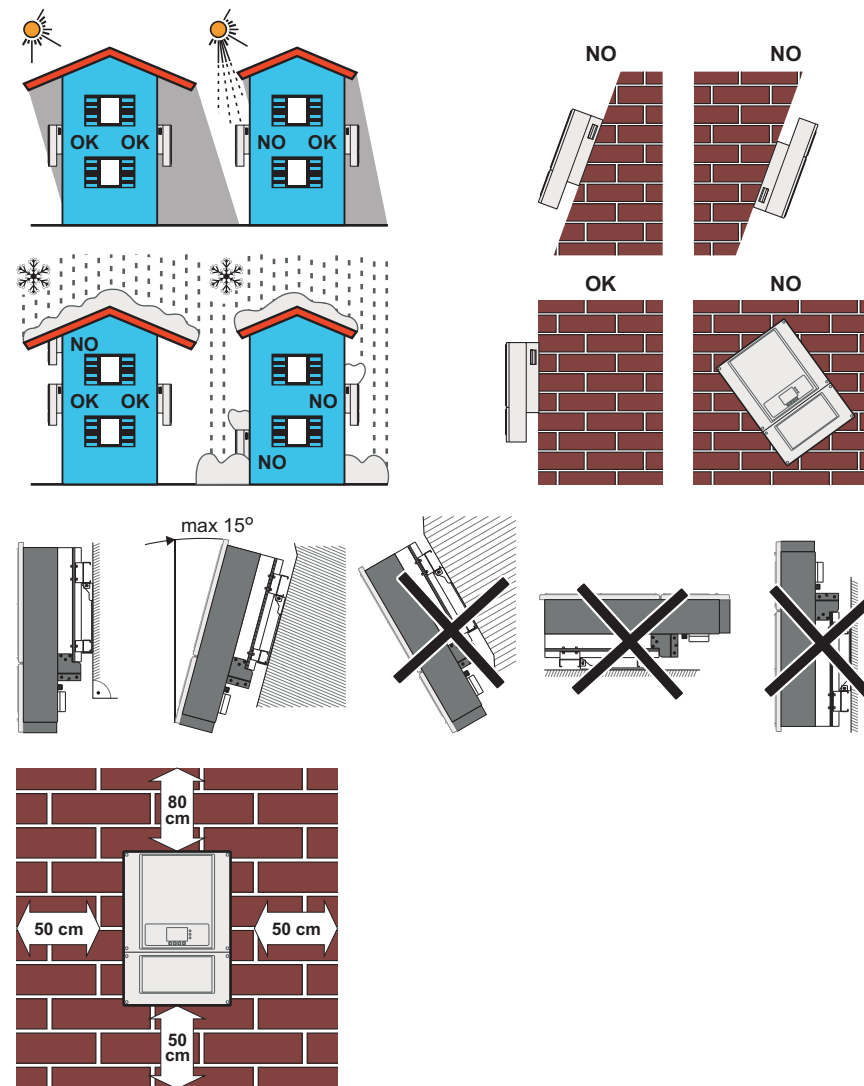

Minimum installation distance for single sofar 30~40KTL

Many sofar 30~40KTL installation

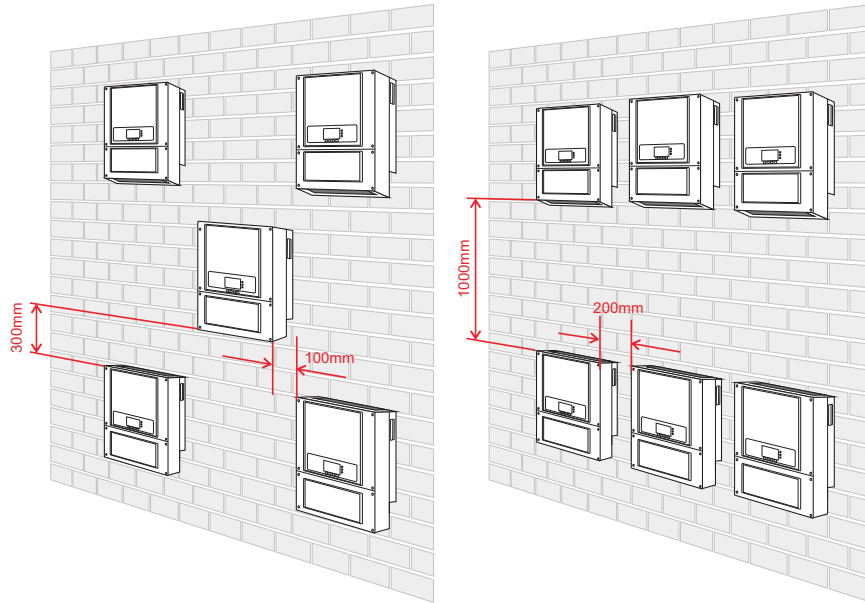

### 3.5 Moving the Sofar 30~40KTL

This topic describes how to move the Sofar 30~40KTL to the installation position horizontally

**Procedure**

**Step 1** Opening the packing, insert hands into the slots on both sides of the Sofar 30~40KTL and hold the handles, as shown in Figure 3-3 and Figure 3-4. Two persons are required to move the Sofar 30~40KTL.

Figure 3-3 Moving the Sofar 30~40KTL (1)

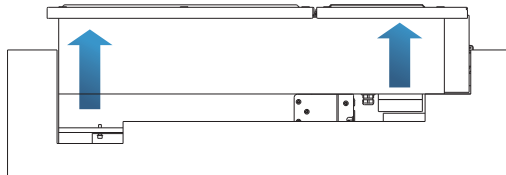
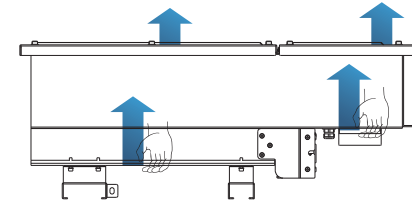

Figure3-4 Moving the Sofar 30~40KTL (2)



**Step 2** Lift the Sofar 30~40KTL from the packing case and move it to the installation position.

	<ul style="list-style-type: none"> <li>To prevent device damage and personal injury, keep balance when moving the sofar 30~40KTL because the Sofar 30~40KTL is heavy.</li> <li>Do not put the Sofar 30~40KTL with its wiring terminals contacting the floor because the power ports and signal ports are not designed to support the weight of the Sofar 30~40KTL. Place the Sofar 30~40KTL horizontally.</li> <li>When placing the Sofar 30~40KTL on the floor, put foam or paper under the Sofar 30~40KTL to protect its shell.</li> </ul>
<b>Attention</b>	

--- End

### 3.6 Installing the Sofar 30~40KTL

**Step 1** To determine the position for drilling holes, level hole positions, and then mark the hole position by using a marker, use the hammer drill to drill hole on the wall. Keeping the hammer perpendicular to the wall, do not shake when drilling, so as not to damage the walls. If the aperture errors, need to reposition.

**Step 2** The expansion screw is vertically inserted into the hole, pay attention to expanding screw insertion depth (not too shallow).

**Step 3** Putting the rear panel on the wall, the rear panel is fixed by the nuts.

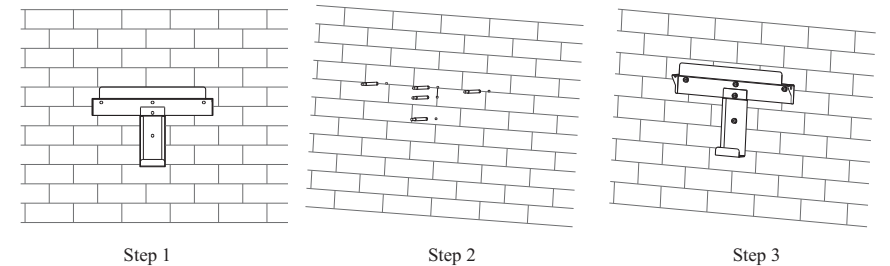

**Step 4** Putting the Sofar 30~40KTL hook on the rear panel.

**Step 5** Using an M4 screw back and inverter bottom fastening, to ensure safety.

**Step 6** Putting the rear panel and inverter to lock together, In order to ensure the safety (the user can select lock according to the actual situation).

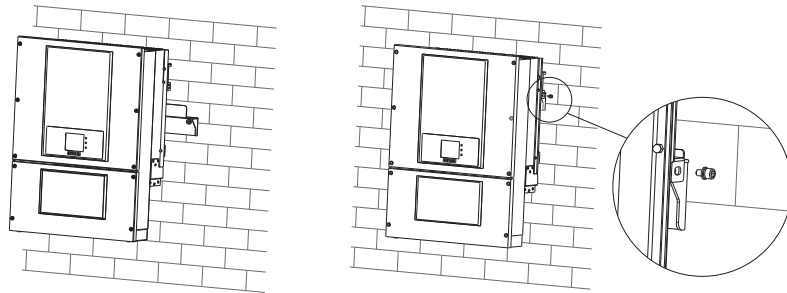

Step 4

Step 5

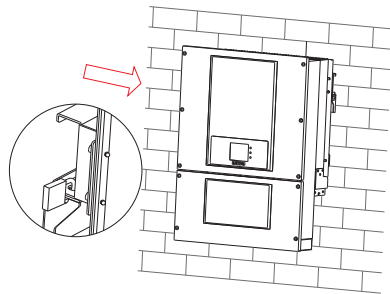

Step 6

--- End

# Electrical Connections

## Outlines of this chapter

This topic describes the Sofar 30~40KTL electrical connections. Read this part carefully before connecting cables.

### NOTE:

Before performing electrical connections, ensure that the DC switch is OFF. Since the stored electrical charge remains in a capacitor long after the DC switch is turned OFF. So it's necessary to wait for at least 5 minutes for the capacitor to be electrically discharged.

	Installation and maintenance of inverter, must be operated by professional electrical engineer.
<b>Attention</b>	
	PV modules generate electric energy before exposed to sunlight and can create an electrical shock hazard. Therefore, before connecting DC input power cable, cover PV modules using opaque cloth.
<b>Danger</b>	
	Sofar 30~40KTL has 2 MPP trackers, all PV modules connected to the same MPPT should have similar rated electrical characteristics (including Isc, Voc, Im, Vm, Pm and temperature coefficients), have the same number of series connected PV modules and be all in the same orientation (azimuth and tilt angle).
<b>Note</b>	

### 4.1 Electrical connection

This topic describes the electrical connection process.

#### 4.2 Connecting PGND Cables

Connect the Sofar 30~40KTL to the grounding electrode using protection ground (PGND) cables for grounding purposes.

#### 4.3 Connecting AC Output Power Cables

Connect the Sofar 30~40KTL to the AC power distribution frame (PDF) or electrical grid using AC output power cables after obtaining approval from local electrical grid operator.

#### 4.4 Connecting Communication Cables

This topic describes the functions of WIFI and RS485 ports and the method of connecting WIFI and RS485 communication cables.

#### 4.5 Connecting DC Input Power Cables

Connect the Sofar 30~40KTL to PV arrays using DC input power cables.

#### 4.6 Safety check

Before start the inverter, comply with the safety precautions and check AC、DC connections.



## 4.1 Electrical connection

Figure4-1 Shows the flowchart for connecting cables to the Sofar 30~40KTL

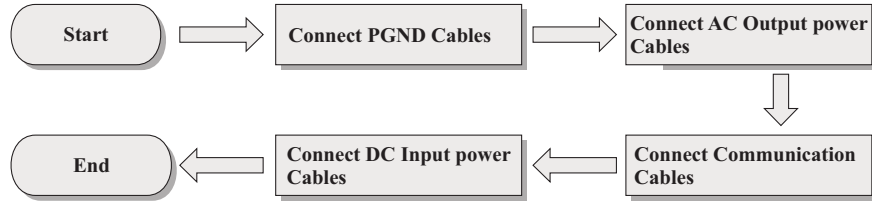

## 4.2 Connecting PGND Cables

Connect the Sofar 30~40KTL to the grounding electrode using protection ground (PGND) cables for grounding purposes.

	<p><b>The inverter is transformerless, Requires The positive pole and the negative pole of the PV array are not grounded, Otherwise it will cause inverter failure, In the PV power generation system, all non current carrying metal parts(such as: Bracket, Junction box shell, inverter shell) should be connected to earth.</b></p>
<b>Attention</b>	



**Note:**

- Good grounding for the Sofar 30~40KTL can help resist the impact of the surge voltage and improve the EMI performance. First connect the PGND cable before connecting the AC power cable, DC power cable, and communication cable.  
For the system with one Sofar 30~40KTL, connect the PGND cable to the ground. For the system with multiple Sofar 30~40KTL, connect the PGND cables of all Sofar 30~40KTL to the grounding electrode using equipotential bonding.
- If the installation location is near the ground, first connect the PGND cable to the ground before installing the Sofar 30~40KTL on the wall.

Figure4-2 Ground terminal composition

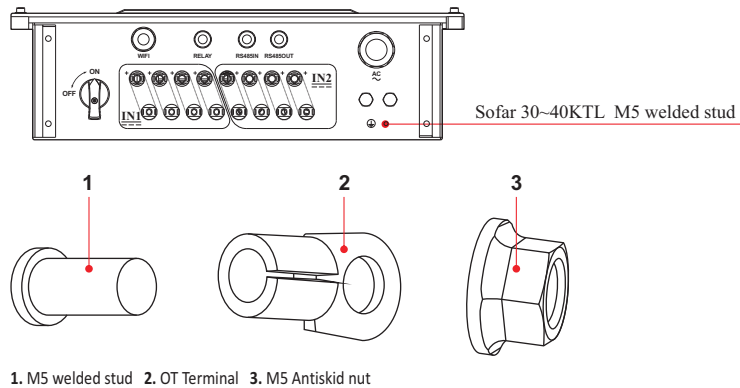

**Prerequisites:**

The PGND cables are prepared (8 AWG outdoor power cables are recommended for grounding purposes).

**Procedure:**

**Step 1** Remove the insulation layer with an appropriate length using a wire stripper, as shown in Figure 4-3.

Figure4-3 Preparing a ground cable (1)

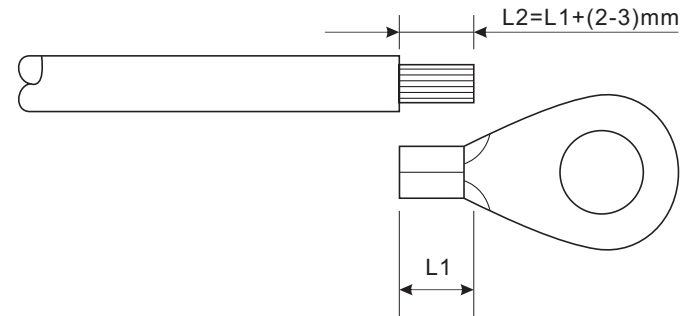

Note : L2 is 2 to 3mm longer than L1

**Step 2** Insert the exposed core wires into the OT terminal and crimp them by using a crimping tool, as shown in Figure 4-4.

Figure4-4 Preparing a ground cable (2)

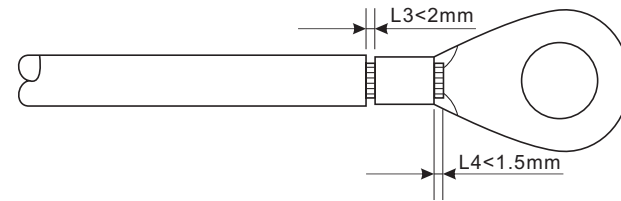

- Note 1:** L3 is the length between the insulation layer of the ground cable and the crimped part. L4 is the distance between the crimped part and core wires protruding from the crimped part.
- Note 2:** The cavity formed after crimping the conductor crimp strip shall wrap the core wires completely. The core wires shall contact the terminal closely.

**Step 3** Install the crimped OT terminal, flat washer, and spring washer on the M6 welded stud, and tighten the nut to a torque of 5 N.m using a socket wrench.



**Note:**

To enhance the anti-corrosion performance of the ground terminals, apply silica gel on them after connecting the ground cable.

--- End

### 4.3 Connecting AC Output Power Cables

Connect the Sofar 30~40KTL to the AC power distribution frame (PDF) or electrical grid using AC output power cables.

 <b>Caution</b>	<ul style="list-style-type: none"> <li>• It is not allowed for several inverters to use the same circuit breaker.</li> <li>• It is not allowed to connect loads between inverter and circuit breaker.</li> </ul>
---	--

#### Context

All the AC output cables used for the inverters are outdoor five-core cables. To facilitate the installation, use flexible cables. Table 4-1 lists the recommended specifications for the cables and the breakers.

Table4-1

Type	Sofar 30000TL-Sx	Sofar 33000TL-Sx	Sofar 40000TL-Sx
Cable(Copper)	≥ 10mm <sup>2</sup>	≥ 10mm <sup>2</sup>	≥ 10mm <sup>2</sup>
Breaker	63A	63A	63A

Note: For the sake of safety, please make sure to use correctly sized cables, otherwise the current makes the cable overheat or overload, even cause a fire.

#### Multi core copper wire

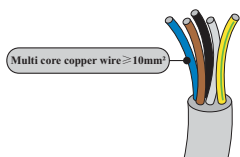

The cross-section of the AC line conductor must be sized in order to prevent unwanted disconnections of the inverter from the grid due to high impedance of the line that connects the inverter to the power supply point; In fact, if the impedance is too high, it causes an increase in the AC voltage that, on reaching the limit set by the country of installation, causes the inverter to switch off Table4-2.

Table4-2

The cable cross-sectional area(mm <sup>2</sup> )	The maximum length(m)		
	Sofar 30000TL-Sx	Sofar 33000TL-Sx	Sofar 40000TL-Sx
10	30	27	27
16	49	44	44

#### Procedure

Sofar 30~40KTL is a three-phase output inverter, strictly comply with local grid-connection requirements and safety standards.

#### Step 1 Open the cover.

Figure4-5 Open the cover schematic diagram

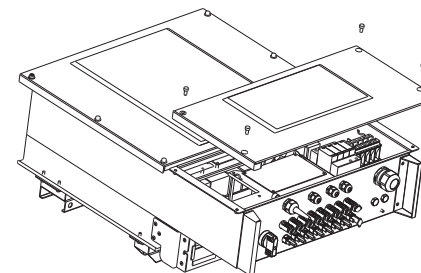

#### Step 2 Remove the insulation layer of an appropriate length according to figure 4-6, then insert the AC output cable through the PG waterproof cable gland.

Figure4-6 AC Output Cable schematic diagram

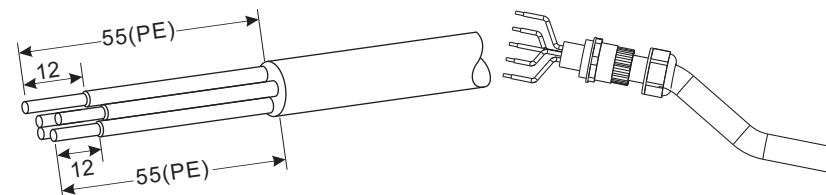

#### Step 3 Connecting the AC output power cable: The AC output cable(R,S,T,N and PE) is connected to the terminal block, as shown in figure 4-7.

Figure4-7 Cable connection schematic diagram

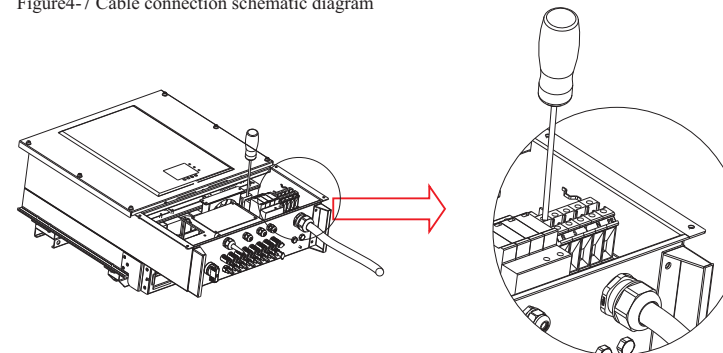

--- End

## 4.4 Connecting Communications Cables

### Connecting Communications Port

Sofar 30~40KTL has two communication interface, RS485 interface, WIFI interface, as shown in the following figure:

Figure 4-8 WIFI/RS485 location map

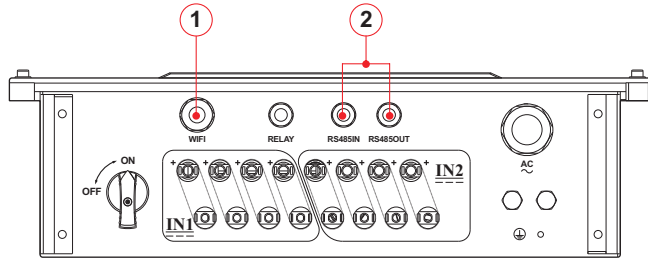

1. RS485 interface 2. WIFI interface

### Connecting RS485 Communications Cables

By the RS485 communication line, connecting Sofar 30~40KTL to communication equipment (such as data acquisition, PC terminal).

You are recommended to use 24 AWG outdoor shielded network cables with the internal resistance less than or equal to 1.5 ohms/10 m and external diameter of 4.5 mm to 7.5 mm as RS485 communications cables.

A waterproof RJ45 connector has six parts: plug, screw nut, seals, housing, sealing plug and cable screw nut, as shown as follow.

Figure 4-9 Waterproof RJ45 connector composition

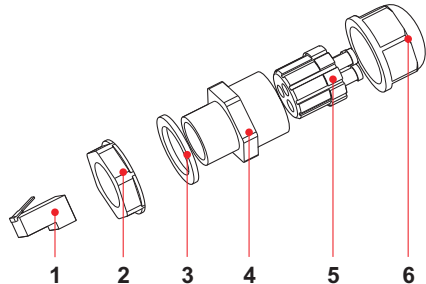

1. Plug 2. Screw nut 3. Seals 4. Housing 5. Sealing Plug 6. Cable Screw nut

When routing communications cables, ensure that communications cables are separated from power cables and away from interference sources to prevent communication interruptions.

### Procedure

**Step 1** Remove the insulation layer of an appropriate length from the shielded network cable using a wire stripper.

**Step 2** Open sof ar 30~40KTL lower cover and insert the shielded network cable into the cable screw nut, seals, screw nut.

**Step 3** Connect the stripped network cable to corresponding pins on the plug, as shown as follow.

Figure 4-11 RS485 Connecting Communications Cables(1)

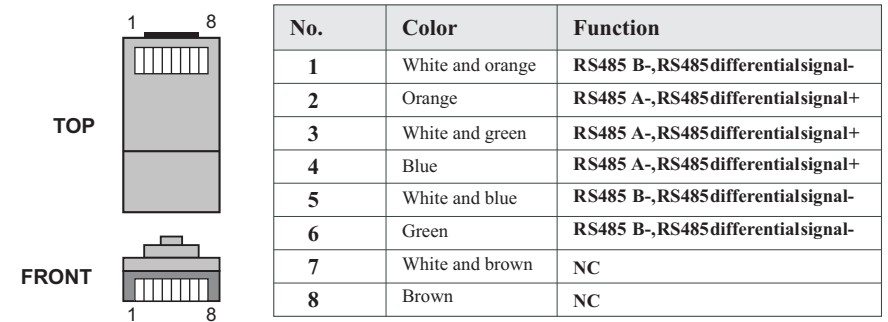
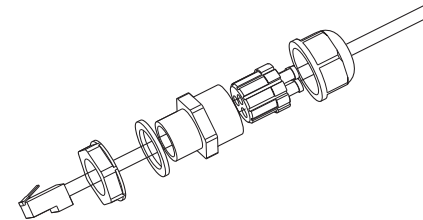

Figure 4-12 RS485 Connecting Communications Cables(2)



**Step 4** Crystal plug with RJ45 crimping tool.

**Step 5** Insert the plug into the RS485 port on the sof ar 30~40KTL.

**Step 6** Insert sealing plug into housing, and tighten the screw nut.

Figure 4-13 RS485 Connecting Communications Cables(3)

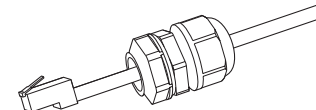

--- End

#### Follow-up Procedure

To remove an RJ45 connector from sof ar 30~40KTL, remove the cable screw nut, press the clip on the RJ45 connector, and then pull out the shielded RJ45 connector.

## Connecting WIFI Communications Cables

By the WIFI communication line, connecting Sofar 30~40KTL to communication equipment (such as data acquisition, PC terminal).

### Procedure

**Step 1** Buckle the antenna to the WIFI module.

Figure 4-13 WIFI Connecting Communications Cables(1)

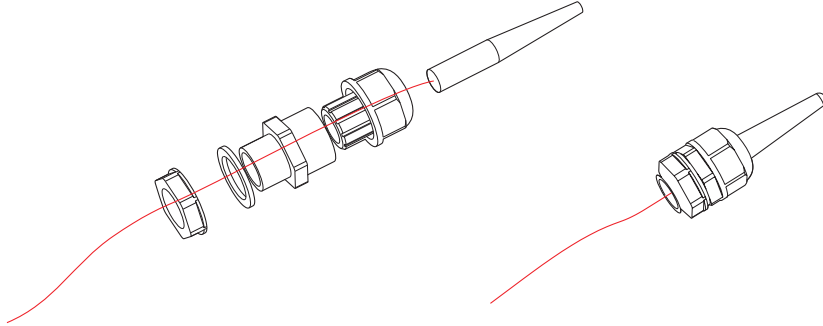

**Step 2** Open Sofar 30~40KTL lower cover and insert the WIFI module to the location as show as follow.

Figure 4-14 WIFI Connecting Communications Cables(2)

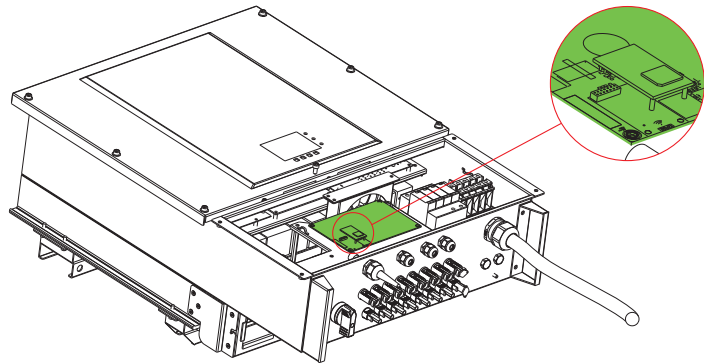

**Step 3** Screw out the sealing nut corresponding, to let the antenna expose a portion, and tighten the screw nut.

Figure 4-15 WIFI Connecting Communications Cables(3)

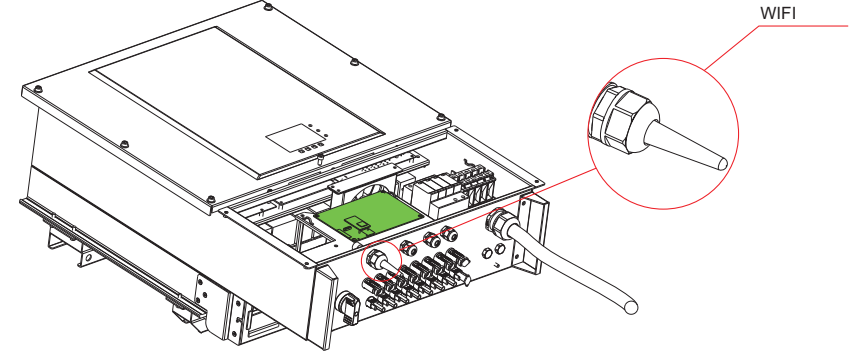

**Note:** Pull the WIFI antenna out a little bit to enhance the signal.

## Communications Port Description

This topic describes the functions of the RS485 and WIFI ports.

### RS485

By RS485 interface, transfer the inverter power output information, alarm information, operation state to the PC terminal or local data acquisition device, then uploaded to the server (such as S-WE01S).

#### 1. USB-RS485

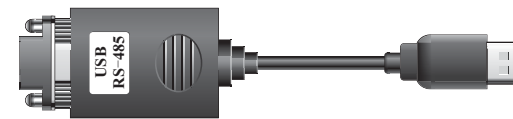

#### 2. S-WE01S

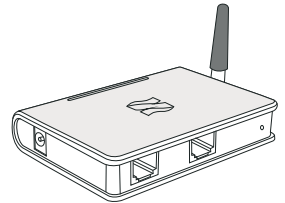

Set the match resistor by the SWT2, the corresponding list as follows (0 OFF, 1 ON).

SWT2_1	SWT2_2	State
0	Reserve	No connect
1	Reserve	Connect

If only one Sofar 30~40KTL is used, use a communication cable with waterproof RJ45 connectors, and choose either of the two RS485 ports and need to set the SWT4(RS485 address as shown in Figure 4-8) and SWT2(Match Resistance as shown in Figure 4-8).

Figure 4-16 A single Sofar 30~40KTL connecting Communications

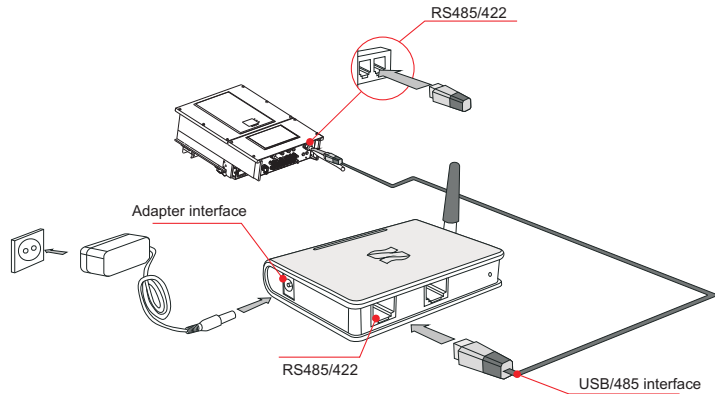

If multiple Sofar 30~40KTL are used, connect all Sofar 30~40KTL in daisy chain mode over the RS485 communication cable. First, set the SWT4(RS485 address dial switch) and SWT2(Match Resistance).

Figure 4-18 Multi Sofar 30~40KTL connecting Communications

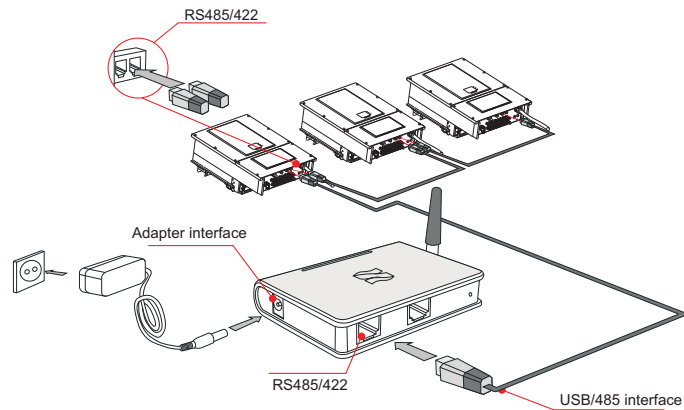

According to the manufacturers to provide SN number can register remote monitoring of Sofar 30~40KTL through <http://www.solarmanpv.com/portal/LoginPage.aspx>.

## WIFI

By the WIFI interface, transfer the inverter power output information, alarm information, operation state to the PC terminal or local data acquisition device, then uploaded to the server (such as S-WE01S).

According to the manufacturers to provide SN number can register remote monitoring of Sofar 30~40KTL through <http://www.solarmanpv.com/portal/LoginPage.aspx>.

Figure 4-19 Connect multiple Wifi to wireless router

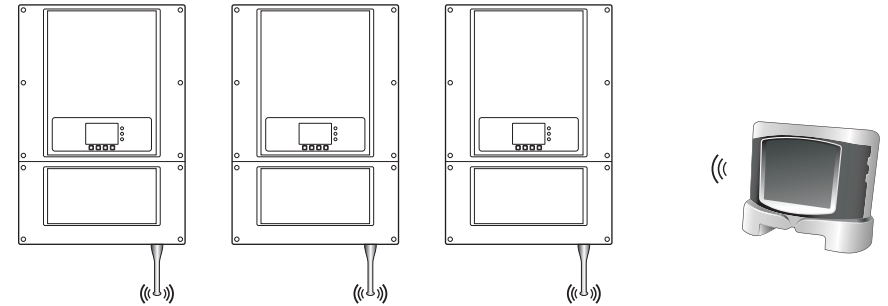

### Note

- The length of the RS485 communication cable should be less than 1000 m.
- The length of the Wifi communication cable should be less than 100 m.
- If multiple Sofar 30~40KTL are connected to the monitoring device over an RS485/RS232 converter, a maximum of 31 inverter can be connected in a daisy chain.
- If multiple Sofar 30~40KTL are connected to a S-WE01S, a maximum of 31 Sofar 30~40KTL can be connected in three daisy chains.

## Connecting Relay Cables

The Sofar 30~40KTL has a multifunctional relay, its output can be configured. The connecting terminal in a communication board, as shown in Figure4-8. Connecting CNT10 view as shown as follow.

It can be connected to the normally open mode (i.e. connecting NO contact and COM contact), can also be configured as a normally closed mode (i.e. connecting NC contact and COM contact).

The Relay has 4 different control function, the details please see the LCD display interface settings on the set relay function description.

### CNT10



NC COM NO

No: normally open contact

COM: common contact

Nc: normally closed contact

## Procedure

**Step 1** To prepare the appropriate cable. The front of a wire stripping will be in accordance with the following picture size, and then through the PG waterproof joint.

Figure 4-19 Relay Connection (1)

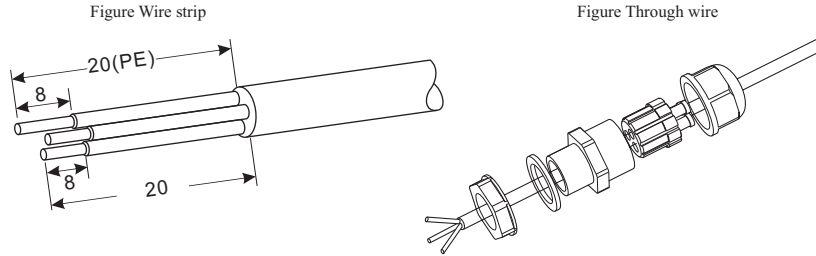

**Step 2** Insert sealing plug into housing, and tighten the screw nut.

Figure 4-20 Relay Connection (2)

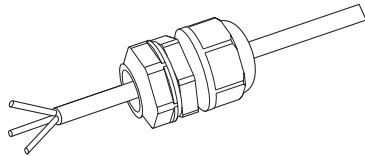

**Step 3** The cable stripped to the corresponding stem node hole.

Figure 4-21 Relay Connection (3)

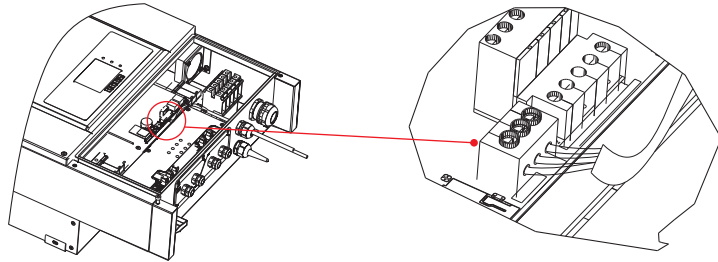

--- End

## 4.5 Connecting DC Input Power Cables

Connect the sofars 30~40KTL to PV arrays over DC input power cables.

Input mode selection : sofars 30~40KTL has 2 MPPT, The two MPPT can run independently, but also can be operated in parallel, According to the system design, the user can choose the mode of MPPT operation.

### Independent mode (default):

If the two MPPT panels is independent, the input mode should be set as "independent mode".

The setting method is introduced at chapter 6.3.

### Parallel mode :

If the two MPPT panels is paralleled together by combiner, the input mode should be set as "parallel mode".

The setting method is introduced at chapter 6.3.



#### Note

According to the inverter type, choose the inverter accessories (cables, fuse holder, fuse, breaker etc.), Sofar inverter with PV array should be excellent performance, reliable quality. The open circuit voltage of PV must be less than Maximum DC input voltage of Sofar inverter, The output voltage of the solar array must be consistent with the MPPT voltage range.

Table4-5 MPPT voltage range



Type	Sofar 30000TL-Sx	Sofar 33000TL-Sx	Sofar 40000TL-Sx
MPPT voltage range	250~960 Vdc	250~960 Vdc	250~960 Vdc
Max. input voltage	1000 Vdc		

DC inductance should choose PV cable, from the junction box to the inverter, line voltage drop is about 1~2%, The inverter is installed in the PV bracket, which saves the cable and reduce the DC loss.



#### Note

- Check polarity of PV array, to ensure the correct wiring of PV array;
- Please don't put the positive or negative of the PV array connect to earth.

	<ul style="list-style-type: none"> <li>PV modules generate electric energy when exposed to sunlight and can create an electrical shock hazard. Therefore, when connecting DC input power cable, cover PV modules by using opaque cloth.</li> <li>Before performing electrical connections, ensure that voltages of the DC cables should be within the safe voltage range, that is, lower than 60 V DC, and the DC SWITCH is OFF. Otherwise, the high voltage may result in fatal danger.</li> </ul>
<b>Danger</b>	
	<p>Ensure that the following conditions are met. Otherwise, fire accident may occur.</p> <ul style="list-style-type: none"> <li>PV modules connected in series in each PV array are of the same specifications.</li> <li>The open-circuit voltage of each PV array is always lower than or equal to 1000 V DC.</li> <li>The open-circuit voltage of each PV array is always lower than or equal to 18 A DC.</li> <li>The output power of each PV array is always less than or equal to the maximum input power of the sofar 30~40KTL.</li> <li>The positive and negative terminals of PV arrays connect to the positive and negative DC input terminals respectively.</li> </ul>
<b>Caution</b>	
	<ul style="list-style-type: none"> <li>If the Sofar 30~40KTL connects to the power grid directly, ensure that the PV arrays are not grounded.</li> <li>If the DC voltage is a non-zero value between the positive terminal of PV arrays and the ground, the PV arrays are subject to insulation faults. Rectify the fault before connecting cables.</li> <li>During PV array and Sofar 30~40KTL installation, the positive or negative terminals of PV arrays may be grounded if power cables are not properly installed or routed. In this case, an DC short circuit may occur and damage the Sofar 30~40KTL.</li> <li>If the PV arrays need to be grounded, install a three-phase four-wire isolation transformer on the output side and disable the ISO detection function by referring to 6.2.10 Setting Isolation Parameters. If an isolation transformer is not installed, the Sofar 30~40KTL may be damaged.</li> </ul>
<b>Note</b>	

Context

Table 4-6 Recommended DC input cable specifications

Cross-Sectional Area (mm)		External Cable Diameter(mm)
Range	Recommended Value	
4.0~6.0	4.0	4.5~7.8

DC input connectors are classified into positive and negative connectors, as shown in Figure 4-24 and Figure 4-25.

Figure 4-23 Positive connector composition

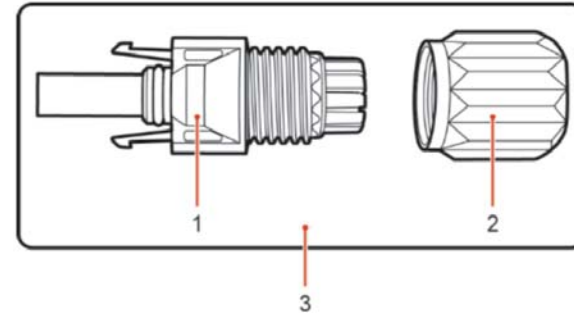

1. Housing 2. Cable gland 3. Positive connector

Figure 4-24 Negative connector composition

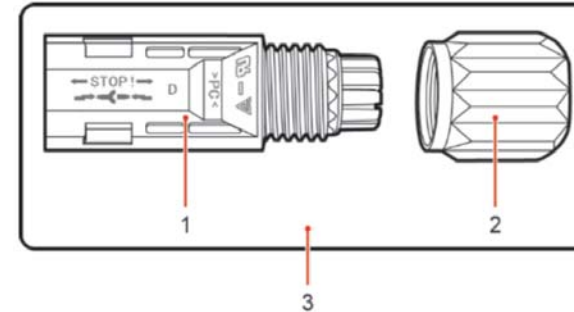

1. Housing 2. Cable gland 3. Negative connector



Note

Positive and negative metal terminals are packed with positive and negative connectors respectively. Separate the positive from negative metal terminals after unpacking the Sofar 30~40KTL to avoid confusing the polarities.



**Procedure**

**Step 1** Remove cable glands from the positive and negative connectors.

**Step 2** Remove the insulation layer with an appropriate length from the positive and negative power cables by using a wire stripper as show in Figure 4-26.

Figure 4-25 Connecting DC input power cables

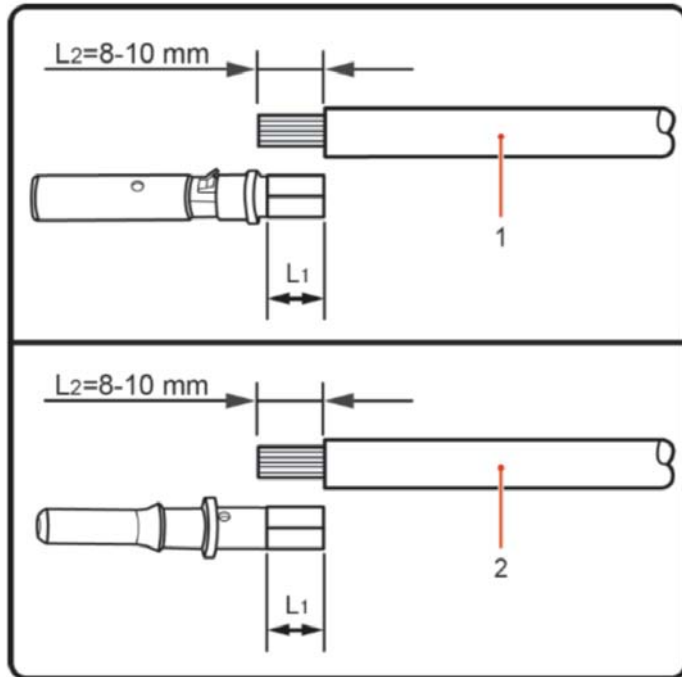

1. Positive power cable 2. Negative power cable



**Note**

L2 is 2 to 3 mm longer than L1.

**Step 3** Insert the positive and negative power cables into corresponding cable glands.

**Step 4** Insert the stripped positive and negative power cables into the positive and negative metal terminals respectively and crimp them using a crimping tool. Ensure that the cables are crimped until they cannot be pulled out by force less than 400 N, as shown in Figure 4-27.

Figure 4-26 Connecting DC input power cables

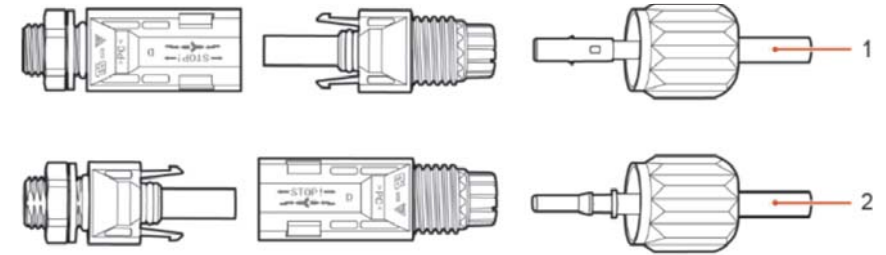

1. Positive power cable 2. Negative power cable

**Step 5** Insert crimped power cables into corresponding housings until you hear a "click" sound. The power cables snap into place.

**Step 6** Reinstall cable glands on positive and negative connectors and rotate them against the insulation covers.

**Step 7** Insert the positive and negative connectors into corresponding DC input terminals of the Sofar 30~40KTL until you hear a "click" sound, as shown in Figure 4-28.

Figure 4-27 Connecting DC input power cables

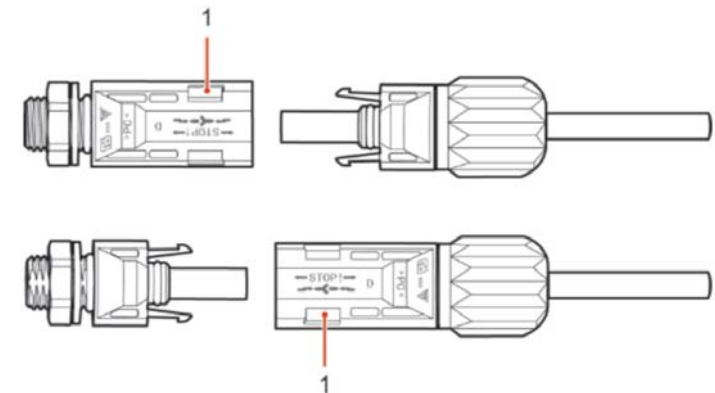

1. Bayonet

--- End

**Follow-up Procedure**

To remove the positive and negative connectors from the Sofar 30~40KTL, insert a removal wrench into the bayonet and press the wrench with an appropriate strength, as shown in Figure 4-29.

	<p>Before removing the positive and negative connectors, ensure that the DC SWITCH is OFF.</p>
<p><b>Caution</b></p>	

Figure 4-28 Removing a DC input connector



**4.6 Safety check**

• **Photovoltaic array**

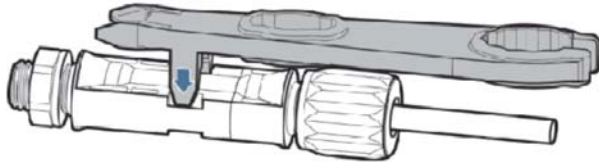
Before the inverter operation, need to be examined for the photovoltaic array, Check Open circuit voltage of the each PV array whether accord with the requirements.

- Ensure Open circuit voltage of the each PV array accord with the requirements;
- Ensure that the positive and negative polarity is correct.

• **Sofar 30~40KTL DC connect**

Use the multimeter to check the DC side voltage and current;

Check the DC cable, Note the positive and negative poles cannot be reversed, Consistent with the positive and negative pole of photovoltaic array, measured each input Open circuit voltage

Compare the voltage, if the difference is greater than 3%, PV array line may be a fault

• **Sofar 30~40KTL AC connect**

Ensure the AC breaker of the inverter is off

Check the inverter phase with grid is connected properly, Check the voltage of each phase is within a predetermined range, if possible, Measure the THD, If the distortion is serious, the inverter may not work.

• **Installing cover and Locking screw.**

Figure4-29 NOT allowed: connect loads between inverter and circuit breaker

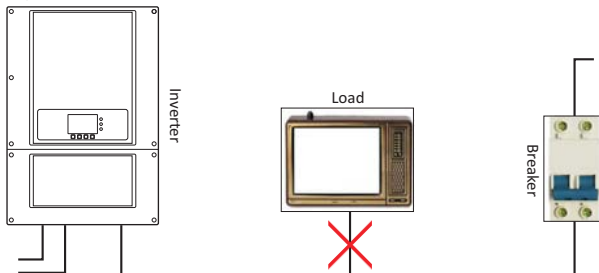

# 5 Commissioning of inverter

## 5.1 Safety inspection before commissioning

	<p>Ensure that DC and AC voltages are within the range permitted by the inverter.</p>
<p><b>Attention</b></p>	

## 5.2 Start inverter

**Step 1** Turn on DC switch.

**Step 2** Turn on AC switch.

When the solar arrays generate adequate power, the inverter will startup automatically. Display showing “normal” indicates correct operation.

If the inverter indicates any other fault, please refer to part 7——error messages for help.

# 6 Operation interface

## Outlines of this chapter

Introduce the display, operation, buttons and LED light of Sofar 30~40KTL.

### 6.1 Operation and Display Panel

#### Buttons and Indicator lights

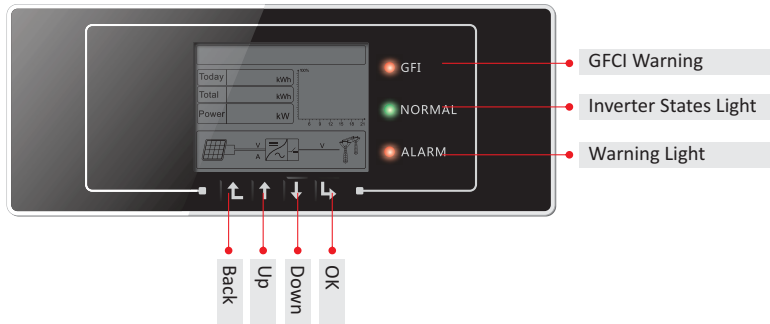

#### Key-button:

- Back : to back up or enter into main interface at standard interface states
- Up : to move up or increase value
- Down : to move down or decrease value
- Enter : to confirm selection

#### Indicator Lights:

- States Light(GREEN)
  - Flashing: Waiting or checking state
  - ON: Normal operation
  - OFF: Fault or permanent state
- Warning Light (RED)
  - Flashing: Fans fault
  - ON: The inverter is faulty
  - OFF: Normal operation
- GFCI Warning Light (RED)
  - ON: GFCI fault
  - OFF: GFCI normal

## 6.2 Standard Interface

LCD standard interface is used to display inverter states, information and parameter setting etc.

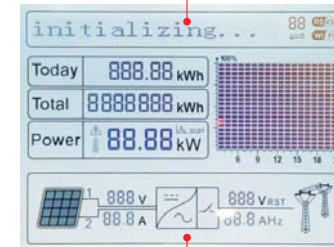

LCD displays the updates of inverter energy, power, input information, warning information etc

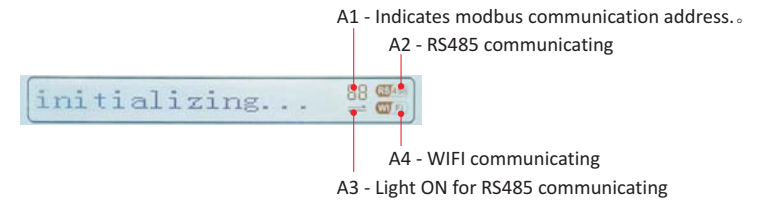

- A5 - Light flashes to warn over frequency and power derating. Light ON to warn remote
- A6 - Indicates today's energy
- A7 - Indicates the total energy



- A10 - MPPT SCAN function is activated (not available)
- A9 - Indicates real time output power
- A8 - Light ON warning for inverter high temperature

- A11 - Light ON when input voltage over 350V
- A12 - Indicates real time input voltage and current channel
- A13 - Indicates the input voltage and current of phase 1&2 and displays in turns in every three seconds
- A14 - Light ON when the state is normal



- A16 - Indicates R/T/S phase current or frequency and displays in turns in every three seconds
- A15 - Indicates R/T/S phase voltage and displays in turns in every three seconds

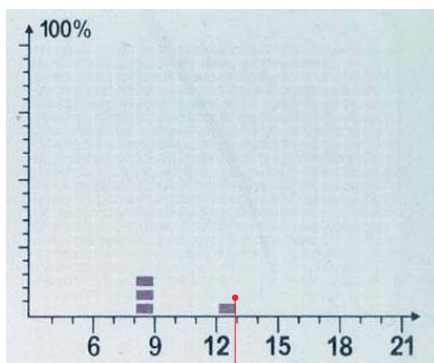

A17 - Indicates the energy from 3:00am-21:00pm in the day

When power-on, LCD interface displays INITIALIZING, refer below picture.

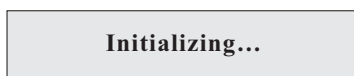

when control board successfully connected with communication board, the LCD display the current state of the inverter, display as shown in the figure below.

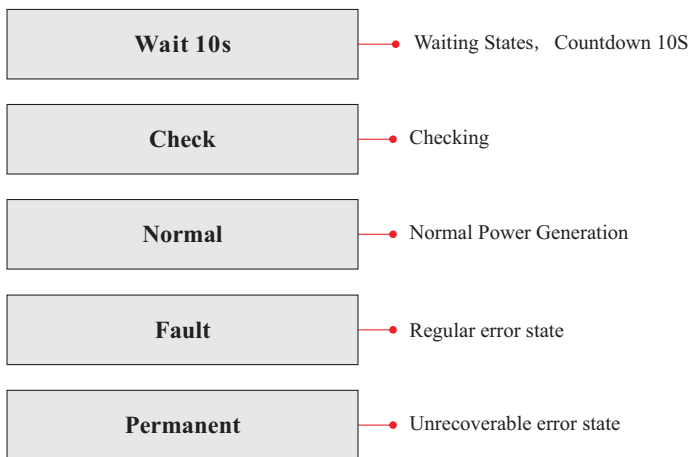

**Inverter states includes: wait, check, normal, fault and permanent**

**Wait :** Inverter is waiting to Check State at the end of reconnection time. In this state, the PV voltage is more than 250V, grid voltage value is between the max and min limits and so on; If not, Inverter will go to Fault State or Permanent State.

**Check:** Inverter is checking isolation resistor, relays, and other safety requirements. It also does self-test to ensure inverter software and hardware are functional. Inverter will go to Fault State or Permanent State if any error or fault occurs.

**Normal :** Inverter enter to Normal State, it is feeding power to the grid; inverter will go to Fault State or Permanent state if any error or fault occurs.

**Fault :** Fault State: Inverter has encountered recoverable error. It should recover if the errors disappear. If Fault State continues; please check the inverter according error code.

**Permanent :** Inverter has encountered unrecoverable error, we need maintainer debug this kind of error according to error code.

When the control board and communication board connection fails, the LCD display interface as shown in the figure below.



### 6.3 Main Interface

Press “Back” button under standard interface to enter into main interface, including:

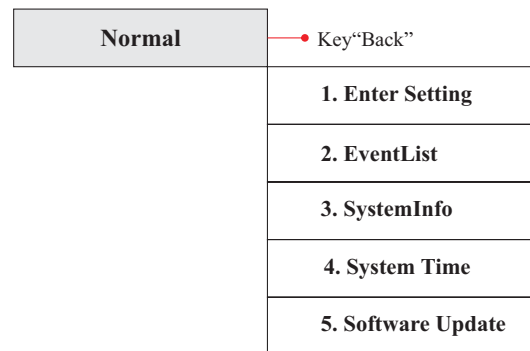

(A) “Enter Setting” Interface as below:

1.Enter Setting	
	1. Set time
	2. Clear Produce
	3. Clear Events
	4. Set Country Code
	5. Remote Control
	6. Relay Command
	7. Enable Set Country
	8. Set Total Energy
	9. Set Mod-bus Address
	10. Set Inputmode
	11. Set Language
	12. Set StartPara
	13. Set SafetyVolt
	14. Set SafetyFreq
	15. Set Insulation
	16. Relay Test

◆ Set Time

Users press “Back” button to enter “1.Enter Setting” interface, Press “OK” button to enter main setting interface. Enter “1. Set Time” by pressing “Up” button or “Down” button, then press “OK” button and start to set up time.

Time set from year, month, day, minutes, and seconds in turns, “Up” button or “Down” button to choose different value to set each date. Set each value is need to press “OK” button to confirm setting. “success” is displayed if the setting time is correct, “fail” means failure settings.

◆ Clear Produce

Users press “Back” button to enter “1.Enter Setting” interface, Press “OK” button to enter main setting interface. Then Enter “2.Clear Produce” by pressing “Up” button or “Down” button, press “OK” button and start to clear produce. “success” is displayed after settings.

◆ Clear Events

Users press “Back” button to enter “1.Enter Setting” interface, Press “OK” button to enter main setting interface. Enter “3. Clear Events” by pressing “Up” button or “Down” button. Press “OK” button and start to clear events. “success” is displayed after settings.

◆ Set Country Code

Users press “Back” button to enter “1.Enter setting” interface, Press OK button to enter main setting interface. Enter “4.Set Country Code” by pressing “Up” button Or “Down” button, press “OK” button and enter “Input Password” Setting interface. If it's shown "set disable" on the screen, then you can NOT choose the operating country, you should enable country setting through "7. Enable Set Country" interface. If it's shown "set Country code?" on the screen, then press Confirm button to start country setting. "Success" will be shown on the screen after a successful country setting.

Table 6-1 country code setting

Code		country	Code		country	Code		country
00	30&33K	Germany VDE AR-N4105	09	30&33K	UK-G59	18	30&33K	EU EN50438
24	40K		33	40K		42	40K	
01	30&33K	Italy CEI0-21	10	30&33K	China	19	30&33K	IEC EN61727
25	40K		34	40K		43	40K	
02	30&33K	Australia	11	30&33K	France	20	30&33K	Korea
26	40K		35	40K		44	40K	
03	30&33K	Spain RD1699	12	30&33K	Poland	21	30&33K	Sweden
27	40K		36	40K		45	40K	
04	30&33K	Turkey	13	30&33K	Germany BDEW	22	30&33K	Europe General
28	40K		37	40K		46	40K	
05	30&33K	Denmark	14	30&33K	Germany VDE 0126	23	30&33K	Customer VDE 0126
29	40K		38	40K		47	40K	
06	30&33K	Greece Continent	15	30&33K	Italy CEI0-16			
30	40K		39	40K				
07	30&33K	Netherland	16	30&33K	UK-G83			
31	40K		40	40K				
08	30&33K	Belgium	17	30&33K	Greece island			
32	40K		41	40K				

◆ Remote Control

Users press "Back" button to enter "1.Enter Setting" interface, Press "OK" button to enter main setting interface. Enter "5. Remote Control" by pressing "Up" button or "Down" button. Press "OK" button and enter Remote Control Switch On & Off interface. Choose "1.Enable" or "2.Disable" by pressing "Up" button or "Down" button, press "OK" button, then communication board start to transmit control signals to control board. "success" is displayed after setting success ; otherwise it will show "fail".

◆ Relay Command

Users press "Back" button to enter "1.Enter Setting" interface, Press "OK" button to enter main setting interface.

Enter "6. Relay Command" by pressing "Up" button or "Down" button, press "OK" button and enter "Relay Command setting" interface. Choose corresponded setting items by pressing "Up" button or "Down" button, then press "OK" button. "success" or "fail" is displayed after setting.

<b>6. Relay Command</b>	
	<b>1. Production</b>
	<b>2. Alarm</b>
	<b>3. Config Alarm</b>
	<b>4. Relay Disable</b>

Relay Command Definition:

<b>Production</b>	<p>the relay switches whenever a connection to (and therefore a disconnection from) the grid occurs.</p> <p>If the relay contractor is in normally open (close) mode, the contact will stay open (or closed) until the inverter is connected to the grid; once the inverter connects to the grid and starts to export power, the relay switches state and therefore closes (or opens).</p> <p>When the inverter disconnects from the grid, the relay contact returns to its position of rest, namely open (or closed).</p>
<b>Alarm</b>	<p>The relay switches whenever there is an alarm on the inverter (Error). No switching occurs when there is a Warning.</p> <p>If the relay contractor is in normally open(close)mode, the contact will stay open (or closed) until the inverter reports an error; once the inverter reports an error, the relay switches state and therefore closes (or opens).The contact remains switched from its rest condition until normal operation is restored.</p>
<b>Config Alarm</b>	<p>the relay switches whenever there is an alarm (Error) or a Warning, which have been previously selected by the user through the PC. the contact will stay open (or closed) until the inverter reports an error or a warning out of those selected from the menu; once the inverter displays an error or a warning out of those selected, the relay switches state and therefore closes (or opens) the contact. The relay remains switched from its rest condition until the alarm or warning has disappeared.</p>
<b>Relay Disable</b>	Control function is forbidden

◆ Enable Set Country

Users press "Back" button to enter "1.Enter Setting" interface, Press "OK" button to enter main setting interface. Enter "7.Enable Set Country" by pressing "Up" button or "Down" button, press "OK" button and enter "Input Password" Setting interface.

Press "Back" button to set passwords (default: 0001), increase or decrease value though pressing "Up" button or "Down" button, press "OK" button to next value setting. "Error! Try again" will be displayed for wrong passwords. Press "Back" button and rekey in the correct passwords. "success" will be displayed if setting successfully,

Attention: when inverter working for power generation over 24h, country setting is forbidden, it can only be set after LCD setting. Key in passwords for country setting through LCD (default: 0001), country setting can be set in 24h after keying in the correct passwords, over 24h, set through LCD again.

◆ Set Address

Users press "Back" button to enter "1.Enter setting" interface, Press "OK" button to enter main setting interface. Enter "9. Set Address" by pressing "Up" button or "Down" button. Press "OK" button and enter setting interface "Success" or "fail" is displayed after setting.

◆ Set inputmode

Input mode selection: sofarsolar 30~40KTL has 2 MPPT, The two MPPT can run independently, and also can be operated in parallel, According to the system design, the user can choose the mode of MPPT operation. The input mode can be setting by the LCD .

Users press "Back" button to enter "1.Enter setting" interface, Press "OK" button to enter main setting interface. Enter "10. Set inputmode" by pressing "Up" button or "Down" button. Press "OK" button and enter setting interface. Choose corresponded setting items by pressing "Up" button or "Down" button, then press "OK" button. "Success" or "fail" is displayed after setting.

◆ Set Language

Users press "Back" button to enter "1.Enter setting" interface, Press "OK" button to enter main setting interface. Enter "11. Set Language" by pressing "Up" button or "Down" button. Press "OK" button and enter setting interface. Choose corresponded setting items by pressing "Up" button or "Down" button, then press "OK" button. "Success" or "fail" is displayed after setting.

◆ Set StartPara

User can change the start parameter by the LCD. First the User need to copy the .TXT file which is used to change the start parameter to the SD card .

Users press Back button to enter "1.Enter setting" interface, Press OK button to enter main setting interface. Enter "12. Set StartPara" by pressing "Up" button Or "Down" button, press "OK" button and enter "Input Password" Setting interface. Press "Back" button to set passwords (default: 0001), increase or decrease value though pressing "Up" button or "Down" button, press "OK" button to next value setting. "Error!" Try again" will be displayed for wrong passwords. Press "Back" button and rekey in the correct passwords. "Success" will be displayed if setting successfully.

◆ **Set SafetyVolt**

User can change the Voltage protection point by the LCD. First the User need to copy the. TXT file which is used to change the Voltage protection point to the SD card .

Users press Back button to enter “1.Enter setting” interface, Press OK button to enter main setting interface. Enter “13. Set SafetyVolt” by pressing “Up” button Or “Down” button, press “OK” button and enter “Input Password” Setting interface. Press “Back” button to set passwords (default: 0001), increase or decrease value though pressing “Up” button or “Down” button, press “OK” button to next value setting. “Error!” Try again” will be displayed for wrong passwords. Press “Back” button and rekey in the correct passwords. “Success” will be displayed if setting successfully.

◆ **Set SafetyFreq**

User can change the Frequency protection point by the LCD. First the User need to copy the. TXT file which is used to change the Frequency protection point to the SD card .

Users press Back button to enter “1.Enter setting” interface, Press OK button to enter main setting interface. Enter “14. Set SafetyFreq” by pressing “Up” button Or “Down” button, press “OK” button and enter “Input Password” Setting interface. Press “Back” button to set passwords (default: 0001), increase or decrease value though pressing “Up” button or “Down” button, press “OK” button to next value setting. “Error!” Try again” will be displayed for wrong passwords. Press “Back” button and rekey in the correct passwords. “Success” will be displayed if setting successfully.

◆ **Set Insulation**

User can change the Insulation protection point by the LCD. First the User need to copy the. TXT file which is used to change the Insulation protection point to the SD card .

Users press Back button to enter “1.Enter setting” interface, Press OK button to enter main setting interface. Enter “15. Set Insulation” by pressing “Up” button Or “Down” button, press “OK” button and enter “Input Password” Setting interface. Press “Back” button to set passwords (default: 0001), increase or decrease value though pressing “Up” button or “Down” button, press “OK” button to next value setting. “Error!” Try again” will be displayed for wrong passwords. Press “Back” button and rekey in the correct passwords. “Success” will be displayed if setting successfully.

◆ **Relay Test**

Users press Back button to enter “1.Enter setting” interface, Press OK button to enter main setting interface. Enter “16. Relay Test” by pressing “Up” button Or “Down” button, then press “OK” button and start test relay. “Success” will be displayed if setting successfully.

(B) “Event List” Interface as below:

Event List is used to display the real-time event records, including the total number of events and each specific ID No. and happening time. User can enter Event List interface through main interface to check details of real-time event records, Event will be listed by the happening time, and recent events will be listed in the front. Please refer to below picture:

Users press “Back” button and “Down” button in standard interface, then enter into 2.Event List” interface.

Press “OK” button to get the total event numbers, show as below:



Press “OK” button again; user can check each event ID number and happening time, see below:

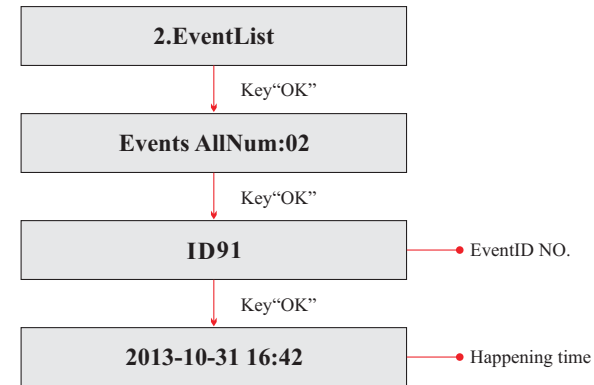



(C) “SystemInfo” Interface as below:

3.SystemInfo	
	1.Inverter Type
	2.Serial Number
	3.SoftVersion
	4.HardVersion
	5.Country
	6.Input Mode
	7.Relay Command

◆ Inverter Type

Users press “Back” button and “Up” button or “Down” button enter “3. SystemInfo” interface, Press “OK” button to enter enter into system information checking interface,then press “Up” button or “Down” button enter into “1. Inverter Type”,then press “OK” button , the Inverter Type will be displayed.

◆ Serial Number

Users press “Back” button and “Up” button or “Down” button to enter “3. SystemInfo” interface, Press “OK” button to enter enter into system information checking interface,then press “Up” button or “Down” button enter into “2. Serial Number”,then press “OK” button ,the serial number will be displayed.

◆ SoftVersion

Users press “Back” button and “Up” button or “Down” button to enter “3. SystemInfo” interface, then Press “OK” button to enter enter into system information checking interface,then press “Up” button or “Down” button enter into “3. SoftVersion”,then press “OK” button , the SoftVersion will be displayed.

◆ HardVersion

Users press “Back” button and “Up” button or “Down” button to enter “3. SystemInfo” interface, then Press “OK” button to enter enter into system information checking interface,then press “Up” button or “Down” button enter into “4. HardVersion”,then press “OK” button , the HardVersion will be displayed.

◆ Country

Users press “Back” button and “Up” button or “Down” button to enter “3. SystemInfo” interface, then Press “OK” button to enter enter into system information checking interface,then press “Up” button or “Down” button enter into “5. Country”,then press “OK” button , the Country will be displayed.

◆ Input Mode

Users press “Back” button and “Up” button or “Down” button to enter “3. SystemInfo” interface, then Press “OK” button to enter enter into system information checking interface,then press “Up” button or “Down” button enter into “6. Input Mode”,then press “OK” button , the Input Mode will be displayed.

◆ Relay Command

Users press “Back” button and “Up” button or “Down” button to enter “3. SystemInfo” interface, then Press “OK” button to enter enter into system information checking interface,then press “Up” button or “Down” button enter into “7. Relay Command”,then press “OK” button , the Relay Command will be displayed.

(D) System Time

Press the “Back” button and “Up” button or “Down” key in the standard user interface to enter into “4.System Time”,then press “OK” button to display the current system time.

(E) Software Update

Press the “Back” button and “Up” button or “Down” button in the standard user interface to enter into “5. Software Update”,then press “OK” button to enter into the“input password” interface,now press the “OK” button to input the password(initial passwords is 0001),Press the“Up” and “Down” button to change the value,then press “OK” button to confirm the current value of input and enter the next set of value .when set over, if the password is wrong, the LCD will display “Error! Try again”,at this time ,you should re-enter your password.If the password is correct, then begin the update process.

online update program steps are as follows:

**Step 1** First, open sofar 30~40KTL lower cover.

**Step 2** After open the lower cover, Press SD card (the SD card as shown in Figure 4-8), Then the SD card will automatically pop up.

**Step 3** The SD card reader must be ready by the users, so that SD card so easy to establish the connection with the computer.

**Step 4** SOFAR SOLAR will send the Software code to the user who needs to update. After user receive the file, please decompressing file and cover the original file in SD card.

**Step 5** Insert the SD card into the SD card slot, there will be a faint clicking sound typically, indicating that has stuck.

**Step 6** then enter into the online upgrade to the main menu “5. Software Update” in the LCD display program. The method to enter the menu can refer to operation interface of LCD.

**Step 7** Input the password, if password is correct, and then begin the update process, the original password is 0001.

**Step 8** System update main DSP、 slave DSP、 FUSE and ARM in turns. If main DSP update success ,the LCD will display “Update DSP1 OK”, otherwise display “Update DSP1 Fail”; If slave DSP update success ,the LCD will display “Update DSP2 OK”, otherwise display “Update DSP2 Fail”; If FUSE update success ,the LCD will display “Update FUSE OK”, otherwise display “Update FUSE Fail”

**Step 9** If Fail , please turn off the DC breaker, wait for the LCD screen extinguish, then turn on the DC breaker again,then Continue to update from step 6.

**Step 10** After the update is completed, turn off the DC breaker, wait for the LCD screen extinguish, then install the lower cover, and turn on the DC breaker and AC breaker again, the inverter will enters the running state.

# Trouble shooting and maintenance

## Outlines of this chapter

This topic describes how to perform daily maintenance and troubleshooting to ensure long-term proper operation of the sofar 30~40KTL inverter.

### 7.1 Trouble shooting

This section contains information and procedures for solving possible problems with the sofar 30~40KTL inverter.

☉ **In case of problem with inverter, check the following tips.**

- Check the warning fault messages or Fault codes on the inverter information panel. Record it before doing anything further.
- If inverter does not display any Fault, please check the following lists.
  - Is the inverter located in a clean, dry, adequately ventilated place?
  - Is the DC switch turned ON?
  - Are the cables adequately sized and short enough?
  - Are the input and output connections and wiring in good condition?
  - Are the configuration settings correct for the particular installation?
  - Are the display panel and the communications cable properly connected and undamaged?

Follow the steps below to view recorded problems:

Press “ESC” to enter the main menu in the normal interface. In the interface screen select “Event List”, then press “OK” to enter events.

☉ **EventList information**

Table 7-1 Eventlist

EventList NO.	EventList Name	EventList description	solution
ID01	GridOVP	The power grid voltage is too high	<ul style="list-style-type: none"> <li>• If the alarm occurs occasionally, the possible cause is that the electric grid is abnormal occasionally. SOFAR inverter automatically returns to normal operating status when the electric grid's back to normal.</li> <li>• If the alarm occurs frequently, check whether the grid voltage/frequency is within the acceptable range. If no, contact SOFAR technical support. If yes, check the AC circuit breaker and AC wiring of the SOFAR inverter.</li> <li>• If the grid voltage/frequency is within the acceptable range and AC wiring is correct, while the alarm occurs repeatedly, contact SOFAR technical support to change the grid over-voltage, under-voltage, over-frequency, under-frequency protection points after obtaining approval from the local electrical grid operator.</li> </ul>
ID02	GridUVP	The power grid voltage is too low	
ID03	GridOFP	The power grid frequency is too high	
ID04	GridUFP	The power grid frequency is too low	

ID05	PVUVP	The input voltage is too low	Check whether too few PV modules are series connected in a PV string, thus the voltage(Vmp) of the PV string is lower than the minimum operating voltage of SOFAR inverter. If yes, adjust the number of series connected PV modules to increase the voltage of the PV string to fit the input voltage range of SOFAR inverter. SOFAR inverter automatically returns to normal operating status after correct adjustments.
ID06	Vlvrtlow	Low voltage across	Check the AC wiring connection to the electric grid, if it's correct, please contact SOFAR technical support.
ID07-ID08	Reserved	Reserved	Reserved
ID09	PvOVP	The input voltage is too high	Check whether too many PV modules are series connected in a PV string, thus the voltage(Voc) of the PV string is higher than the maximum input voltage of SOFAR inverter. If yes, adjust the number of series connected PV modules to decrease the voltage of the PV string to fit the input voltage range of SOFAR inverter. SOFAR inverter automatically returns to normal operating status after correct adjustments.
ID10	IpvUnbalance	Input current is not balanced	Check the input mode(parallel mode/ independent mode) setting of SOFAR inverter according to Section 4.5 of this user manual.
ID11	PvConfigSetWrong	Incorrect input mode	
ID12	GFCIFault	GFCI Fault	<ul style="list-style-type: none"> <li>• If the fault occurs occasionally, the possible cause is that the external circuits are abnormal occasionally. SOFAR inverter automatically returns to normal operating status after the fault is rectified.</li> <li>• If the fault occurs frequently and lasts a long time, check whether the insulation resistance between the PV array and earth(ground) is too low, then check the insulation conditions of PV cables.</li> </ul>
ID13	Reserved	Phase sequence errors	Reserved
ID14	HwBoostOCP	The input current is too high, and has happened hardware protection	Check whether the input current is higher than the maximum input current of SOFAR inverters, then check the input wiring, if both are correct, please contact SOFAR technical support.
ID15	HwAcOCP	The grid current is too high, and has happened hardware protection	ID15-ID24 are internal faults of SOFAR inverter, turn OFF the “DC switch”, wait for 5 minutes, then turn ON the “DC switch”. Check whether the fault is rectified. If no, please contact SOFAR technical support.
ID16	AcRmsOCP	The grid current is too high	
ID17	HwADFaultGrid	The grid current sampling error	
ID18	HwADFaultDCI	The DCI sampling error	
ID19	HwADFaultVGrid	The grid voltage sampling error	
ID20	GFCIDeviceFault	The GFCI sampling error	
ID21	MChip_Fault	The master chip fault	
ID22	HwAuxPowerFault	The auxiliary voltage error	
ID23	BusVoltZeroFault	The bus voltage sampling error	
ID24	IacRmsUnbalance	The Output current is not balanced	

<b>ID25</b>	BusUVP	The bus voltage Is too low	If the PV array configuration is correct (no ID5 fault), the possible cause is that the solar irradiance is too low. SOFAR inverter automatically returns to normal operating status after the solar irradiance returns to normal level.
<b>ID26</b>	BusOVP	The bus voltage Is too high	ID26-ID27 are internal faults of SOFAR inverter, turn OFF the “DC switch”, wait for 5 minutes, then turn ON the “DC switch”. Check whether the fault is rectified. If no, please contact SOFAR technical support.
<b>ID27</b>	VbusUnbalance	The bus voltage is not balanced	
<b>ID28</b>	DciOCP	The Dci is too high	<ul style="list-style-type: none"> <li>• Check the input mode(parallel mode/ independent mode) setting of SOFAR inverter according to Section 4.5 of this user manual.</li> <li>• If the input mode is correct, turn OFF the “DC switch”, wait for 5 minutes, then turn ON the “DC switch”. Check whether the fault is rectified. If no, please contact SOFAR technical support.</li> </ul>
<b>ID29</b>	SwOCPInstant	The grid current is too high	Internal faults of SOFAR inverter, turn OFF the “DC switch”, wait for 5 minutes, then turn ON the “DC switch”. Check whether the fault is rectified. If no, please contact SOFAR technical support.
<b>ID30</b>	SwBOCPInstant	The input current is too high	Check whether the input current is higher than the maximum input current of SOFAR inverters, then check the input wiring, if both are correct, please contact SOFAR technical support.
<b>ID31- ID48</b>	Reserved	Reserved	Reserved
<b>ID49</b>	ConsistentFault_VGrid	The grid voltage sampling value between the master DSP and slave DSP is not consistent	ID49-ID55 are internal faults of SOFAR inverter, turn OFF the “DC switch”, wait for 5 minutes, then turn ON the “DC switch”. Check whether the fault is rectified. If no, please contact SOFAR technical support.
<b>ID50</b>	ConsistentFault_FGrid	The grid frequency sampling value between the master DSP and slave DSP is not consistent	
<b>ID51</b>	ConsistentFault_DCI	The DCI sampling value between the master DSP and slave DSP is not consistent	
<b>ID52</b>	ConsistentFault_GFCI	The GFCI sampling value between the master DSP and slave DSP is not consistent	
<b>ID53</b>	SpiCommLose	The spi communication between the master DSP and slave DSP is fault	
<b>ID54</b>	SciCommLose	The Sci communication between the control board communication board is fault	
<b>ID55</b>	RelayTestFail	The relays fault	
<b>ID56</b>	PvIsoFault	The insulation resistance is too low	
<b>ID57</b>	OverTempFault_Inv	The inverter temp is too high	
<b>ID58</b>	OverTempFault_Boost	The Boost temp is too high	
<b>ID59</b>	OverTempFault_Env	The environment temp is too high	<ul style="list-style-type: none"> <li>• Ensure the installation position and installation method meet the requirements of Section 3.4 of this user manual.</li> <li>• Check whether the ambient temperature of the installation position exceeds the upper limit. If yes, improve ventilation to decrease the temperature.</li> <li>• Check whether the ID90-ID92 fault (fan fault) exist, if yes, please replace the corresponding fan.</li> </ul>
<b>ID60- ID64</b>	Reserved	Reserved	Reserved

<b>ID65</b>	UnrecoverHwAcOCP	The grid current is too high, and has cause unrecoverable hardware fault	ID65-ID70 are internal faults of SOFAR inverter, turn OFF the “DC switch”, wait for 5 minutes, then turn ON the “DC switch”. Check whether the fault is rectified. If no, please contact SOFAR technical support.
<b>ID66</b>	UnrecoverBusOVP	The bus voltage is too high, and has cause unrecoverable fault	
<b>ID67</b>	UnrecoverIacRmsUnbalance	The grid current is unbalance, and has cause unrecoverable fault	
<b>ID68</b>	UnrecoverIpvUnbalance	The input current is unbalance, and has cause unrecoverable fault	
<b>ID69</b>	UnrecoverVbusUnbalance	The bus voltage Is unbalance, and has cause unrecoverable fault	
<b>ID70</b>	UnrecoverOCPInstant	The grid current is too high, and has cause unrecoverable fault	
<b>ID71</b>	UnrecoverPvConfigSetWrong	Incorrect input mode	Check the input mode(parallel mode/ independent mode) setting of SOFAR inverter according to Section 4.5 of this user manual.
<b>ID71- ID73</b>	Reserved	Reserved	Reserved
<b>ID74</b>	UnrecoverIPVInstant	The input current is too high, and has happen unrecoverable fault	ID74-ID77 are internal faults of SOFAR inverter, turn OFF the “DC switch”, wait for 5 minutes, then turn ON the “DC switch”. Check whether the fault is rectified. If no, please contact SOFAR technical support.
<b>ID75</b>	UnrecoverWRITEEEPROM	The EEPROM is unrecoverable	
<b>ID76</b>	UnrecoverREADEEPROM	The EEPROM is unrecoverable	
<b>ID77</b>	UnrecoverRelayFail	Relay has happen permanent fault	
<b>ID78- ID80</b>	Reserved	Reserved	Reserved
<b>ID81</b>	OverTempDerating	the inverter has derated because of the temperature is too high	<ul style="list-style-type: none"> <li>• Ensure the installation position and installation method meet the requirements of Section 3.4 of this user manual.</li> <li>• Check whether the ambient temperature of the installation position exceeds the upper limit. If yes, improve ventilation to decrease the temperature.</li> <li>• Check whether the ID90-ID92 fault (fan fault) exist, if yes, please replace the corresponding fan.</li> </ul>
<b>ID82</b>	OverFreqDerating	the inverter has derated because of the grid frequency too high	SOFAR inverter automatically reduce the output power when the frequency of electrical grid is too high.
<b>ID83</b>	RemoteDerating	The inverter has derated by the Remote control	SOFAR inverter records ID83 in case of remote power derating operation. Check the wiring of remote input and output control signal port on the communication board according to Section 4.4 of this user manual.
<b>ID84</b>	RemoteOff	The inverter has shut down because by the Remote control	SOFAR inverter records ID84 in case of remote shutdown operation. Check the wiring of remote input and output control signal port on the communication board according to Section 4.4 of this user manual.
<b>ID85- ID89</b>	Reserved	Reserved	Reserved

<b>ID90</b>	Fan3 alarm	The fan3 is fault	Check whether the internal fan is not working, if so, replace the fan, if the alarm still exists after the replacement, please contact SOFAR technical support.
<b>ID91</b>	Fan1 alarm	The fan1 is fault	Check whether the external fan with blue heat-shrink tubing is not working, if so, replace the fan, if the alarm still exists after the replacement, please contact SOFAR technical support.
<b>ID92</b>	Fan2 alarm	The fan2 is fault	Check whether the external fan with red heat-shrink tubing is not working, if so, replace the fan, if the alarm still exists after the replacement, please contact SOFAR technical support.
<b>ID93</b>	Lightning protection alarm	There has Lightning happen	Check the lightning protection module, if it's undamaged, please contact SOFAR technical support.
<b>ID94</b>	Software version is not consistent	The Software between the control board and the communication board is not consistent	Contact SOFAR technical support to upgrade software.
<b>ID95</b>	Communication board EEPROM fault	The Communication board EEPROM is fault	ID95-ID96 are internal faults of SOFAR inverter, turn OFF the "DC switch", wait for 5 minutes, then turn ON the "DC switch". Check whether the fault is rectified. If no, please contact SOFAR technical support.
<b>ID96</b>	RTC clock chip anomaly	RTC clock chip is fault	
<b>ID97</b>	Invalid Country	The Country is InValid	Check the country setting according to Section 4.4 of this user manual.
<b>ID98</b>	SD fault	The SD card is fault	Please replace the SD card.
<b>ID99- ID100</b>	Reserved		Reserved

## 7.2 Maintenance

Inverters generally do not need any daily or routine maintenance. Cooling fan should not be blocked by dust or any other items.

### ⊙ Inverter cleaning

Please use hand blower, soft dry cloth or brush to clean inverters. Water, corrosive chemical substances or intense cleaning agent should not be used for cleaning the cooling fan or inverter. Switch off AC and DC power supply to inverter before undertaking any cleaning activity.

### ⊙ Cooling fin cleaning

For the long-term proper operation of SOFAR inverters, ensure there is enough space around the heat sink for ventilation, check the heat sink for blockage (dust, snow, etc.) and clean them if they exist. Please clean the heat sink with an air blower, a dry & soft cloth or a soft bristle brush. Do NOT clean the heat sink with water, corrosive chemicals, detergent, etc.

# 8 Decommissioning

## Outlines of this chapter

This topic describes how to remove, pack, and dispose the Sofar 30~40KTL inverter.

### 8.1 Decommissioning steps

- Switch off the AC grid
- Switch Off the DC switch
- Wait for 5 minutes
- Release the DC connectors
- Release the AC terminals using screw drivers.

Remove inverter from the mounting carefully to avoid injury. Please note that the Sofar 30~40KTLs inverter's weight over 45 kgs.

### 8.2 Package

If possible, please pack the inverter in the original packaging. If original packing it is not available, use an equivalent carton suitable for loads more than 50 kg, has handle and can be closed fully.

### 8.3 Storage

Store the inverter in a dry place where ambient temperature is between -25 and +70 °C.

### 8.4 Disposal

At the end of its life, dispose inverters and packing materials at locations that can handle and or recycle electric equipment safely.

# 9) Technical data

## Outlines of this chapter

This topic lists the technical specifications for all Sofar 30~40KTL inverters.

### 9.1 Input parameter (DC)

Parameter	Sofar 30000TL	Sofar 33000TL	Sofar 40000TL
Max. input voltage	1000V		
Start-up input voltage	350V (+/-1v)		
Number of independent MPPT	2		
Number of DC inputs	4 for each MPPT		
Input range with Full power operation with 2 MPPT parallel	480V-800V		560V-800V
Max DC power for single MPPT	15360(480V-800V)	17000(480V-800V)	20400(560V-800V)
Operating input volt range	250V-960V		
Max. input MPPT current	32A/32A	35A/35A	
Input short circuit current for each MPPT	38A	42A	
Overvoltage category of input	III(II-S1,S2 version)		

### 9.2 Output parameter (AC)

Parameter	Sofar 30000TL	Sofar 33000TL	Sofar 40000TL
Rated power	27600W	30000W	36000W
Max. AC power	30000VA	33000VA	40000VA
Rated AC voltage	3/N/PE,230/400Vac		3/N/PE,277/480Vac或 3/PE,480Vac
Grid voltage range	310-480Vac(adjustable )		422-528Vac
Grid frequency range	44~55Hz/54~66Hz(adjustable, must meet local grid requirements)		
Active power adjustable range	0~100%		
Max. output current	43A	48A	
THDI	<3%		
Power factor	1 ( adjustable +/-0.8)		
Overvoltage category of output	III(II-S2version)		

### 9.3 Efficiency, Safety and Protection

Parameter	Sofar 30000TL	Sofar 33000TL	Sofar 40000TL
Max efficiency	98.5%		98.7%
Weighted eff. (EU/CEC)	98.2%		98.4%
Self-consumption at night	<1W		
Feed in start power	45W		
MPPT efficiency	>99.5%		
DC reverse polarity protection	Yes		
DC switch	Yes		
Input/output SPD(II)	Input SPD(II): (S1, S2 version) Output SPD(II): (S2 version)		
Safety protection	Anti islanding, RCMU, Ground fault monitoring		
Certification	CE,CGC,AS4777,AS3100,VDE4105,C10-C11, G59(more available on request )		
Communication	RS485, Wifi(option), Multi-function relay		
Power management unit	According to certification and request		

## 9.4 General Data

Parameter	Sofar 30000TL	Sofar 33000TL	Sofar 40000TL
Ambient temperature range	-25°C... +60°C		
Allowable relative humidity range	0...95% no condensing		
Topology	Transformerless		
Degree of protection	IP65		
Max. operating altitude	2000m		
Noise	<30dB	<45dB	
Weight	50kg		
Cooling	Nature	Fan	
Dimension	773*564*258mm		
Warranty	5 years		

## Quality Assurance

Shenzhen SOFARSOLAR Co., Ltd offers 5 years product warranty for Sofar 30~40KTL inverters from date of installation. However the warranty period can't exceed 66 months from the date of delivery of the inverter. During the warranty period, Shenzhen SOFARSOLAR Co., Ltd guarantees normal operation of the inverter.

If during the warranty period, the inverter develops fault, please contact your installation contractor or supplier. In case of faults falling within manufacturers' responsibility, Shenzhen SOFARSOLAR Co., Ltd will provide service and maintenance free of any charge.

### Disclaimer:

- Use of Sofar 30~40KTL inverters for any other purpose than intended;
- Faulty system design or installation;
- Improper operation;
- Use wrong protection settings on the inverter;
- Carry out unauthorized modification on the inverter.
- Damage because of external factors or the majeure force (such as lightning, over-voltage, bad weather, fire, earthquake, tsunami etc);